



Radio Technology Somfy®

# Pocket Programming Guide



somfy®

## The easiest way to program Somfy motors right in your smartphone



- Simple, intuitive, regularly updated with new products
- Available in multiple languages, also off-line
- Visual step-by-step instructions, favorite function



**somfy**<sup>®</sup>

# TABLE OF CONTENTS

**HOW DOES RTS WORK? ..... 1**

**IDENTIFY RTS CONTROL OPTIONS ..... 2**

## TRANSMITTERS

Situo® RTS Hand-held Remote .....	4
Telis Hand-held Remote .....	5
Telis Soliris Hand-held Remote .....	6
Telis Modulis Hand-held Remote .....	7
Telis 16 RTS Hand-held Remote .....	8
Telis 1 Chronis RTS Hand-held Remote .....	9
Smoove® 1 RTS Wall Switch.....	10
DecoFlex WireFree™ RTS Wall Switch .....	11
DecoFlex WireFree™ RTS Table Top Accessory .....	12

## RECEIVERS

Outdoor Lighting Receiver .....	13
Outdoor Universal Receiver .....	14
Dimmable LED RTS Light Kit .....	15

## INTERFACES

Universal RTS Interface (URTSI) .....	16
myLink™ .....	17

## REPEATER

RTS Repeater .....	18
--------------------	----

## SENSORS

Sunis Indoor WireFree™ RTS Sun Sensor .....	19
ThermoSunis Indoor WireFree™ RTS Sun & Temp. Sensor .....	20
Sunis Outdoor WireFree™ RTS Sun Sensor .....	21
Eolis 3D WireFree™ RTS Wind Sensor .....	22
Ondeis® WireFree RTS Rain & Sun Sensor .....	23

**UNDERSTANDING CONTROL OPTIONS.....24**

Individual Control .....	25
Group Control .....	26
Individual & Group Control.....	27

**PRODUCT APPLICATION & MOTOR  
COMPATIBILITY CHART ..... 28-30**

**PROGRAMMING GUIDES - GETTING STARTED..... 32-33**

## STANDARD RTS QUICK PROGRAMMING..... 34-45 FOR THE FOLLOWING RTS MOTORS:

CL32 Cord Lift WireFree™	Altus® 40
R28 Roll Up WireFree™	ST50 Sonesse® 50
Roll Up 28 WireFree™	Altus® 50
ST30 Sonesse® 30	Altus® 60
ST40 Sonesse® 40	

## QUICK PROGRAMMING GUIDES FOR MOTORS WITH EMBEDDED LI-ION RECHARGEABLE BATTERIES....46-54

Roll Up 24 WireFree™ (Li-ion)	Sonesse® ULTRA 30 WireFree (Li-ion)
Sonesse® 28 WireFree (Li-ion)	Sonesse® 30 WireFree (Li-ion)
Roll Up 28 WireFree™ (Li-ion)	Sonesse® 40 WireFree (Li-ion)

## OTHER QUICK PROGRAMMING GUIDES FOR MOTORS:

Tilt 50 WireFree™ RTS	58-63
LT RTS CMO	64-68
Maestria™ 50 RTS	69-77
Sunea® RTS CMO	78-83
Oximo™ RTS	84-89

## QUICK PROGRAMMING GUIDE FOR DRAPERY MOTORS..90-97

Glydea®	Irismo™ 35 Mini DC
Glydea® ULTRA	Irismo™ 45 WireFree

## QUICK PROGRAMMING GUIDES - CONTROLS

Outdoor Lighting Receiver RTS.....	98
Outdoor Universal Receiver RTS .....	99
Dimmable LED RTS Light Kit .....	100-104
RTS Repeater .....	105
Universal RTS Interface (URTSI) .....	105
myLink™ .....	106-110
Sunis Indoor WireFree™ RTS Sun Sensor .....	111-115
ThermoSunis Indoor WireFree™ RTS Sensor.....	116-120
Sunis Outdoor WireFree™ RTS Sun Sensor .....	121-122
Eolis 3D WireFree™ RTS Wind Sensor .....	123-125
Ondeis® WireFree RTS Rain & Sun Sensor .....	126-131
Telis 16 RTS.....	132-133
Telis 1 Chronis RTS .....	134-138

## TROUBLESHOOTING ..... 139

# How Does It Work?



Simply press a button on a remote control or wall switch and window coverings, awnings, screens or rolling shutters move with ease. There is no need to point or aim the transmitter at the covering because Radio Technology Somfy® (RTS) is omni-directional. And just like a garage door opener, the radio waves travel through walls.

- Available with hand-held remotes, wireless wall switches, table top controls, timers and a convenient app.
- In optimal conditions offers a range of up to 25 ft. for easy operation. Range varies depending on the job site.
- No extra wires are needed.
- Available in single and multi-channel versions, provides the ability to control all motorized window coverings individually and/or as a group with one control.
- Flexibility to change user preferences with simplified programming.
- Over 270 million users worldwide enjoy more than 170 million motors produced by Somfy.
- Secure operation with a rolling code reduces interference with other radio products.
- Offers simplified integration with home automation systems and voice control of RTS products.

# Identify RTS Control Options

## TRANSMITTERS

### Hand-held Remotes

Users can control motorized window coverings by pressing a button or rolling a scroll wheel on a variety of hand-held RTS remotes.

### WireFree Wall Switches

Users can easily control their motorized window coverings when entering or exiting a room with DecoFlex WireFree™ RTS Wall Switches.

### Table Top Remotes

Users can control their motorized window coverings with the versatile DecoFlex WireFree™ RTS Table Top Accessory remote.

## RECEIVERS

Users can adjust window coverings powered by standard motors, as well as operate incandescent and halogen lights and other outdoor devices by using a Somfy RTS receiver.

## INTERFACES

Users can convert Infrared, RS232, RS485 and WiFi protocol into RTS, allowing for 3rd party control of motorized window coverings.

## REPEATER

Users can extend the range of motorized window covering control.

## SENSORS

Users can set sensors to automatically adjust motorized window coverings, awnings, screens etc... in accordance to the amount of sunlight received, temperature recorded, rain, as well as acceleration movement of the awning due to the speed and direction of wind.

# Control Options



# Situo® RTS Hand-held Remote

## FEATURES

UP Button

The MY button acts as a stop button when the window covering is in motion. When the window covering is stationary, the MY button brings it to the programmed favorite position.

DOWN Button

Channel LED - All 4 lights will illuminate when fifth channel is activated.

Channel Selection Button



- ● ● ● Channel 1
- ● ● ● Channel 2
- ● ● ● Channel 3
- ● ● ● Channel 4
- ● ● ● Channel 5

Situo 5 RTS Pure  
Hand-held Remote  
1800139

Programming Button  
(recessed)



Back view  
of remote



Situo 1 RTS also available  
1800128



# Telis RTS Hand-held Remote

## FEATURES

UP Button

The MY button acts as a stop button when the window covering is in motion. When the window covering is stationary, the MY button brings it to the programmed favorite position.

DOWN Button

Channel LED - All 4 lights will illuminate when fifth channel is activated.

Channel Selection Button



- ● ● ● Channel 1
- ● ● ● Channel 2
- ● ● ● Channel 3
- ● ● ● Channel 4
- ● ● ● Channel 5

Telis 4 RTS Pure  
Hand-held Remote  
1810633  
*Telis 1 RTS also available*

Also available in other finishes:



Silver



Lounge



Patio

Programming  
Button  
(recessed)



Back view  
of remote

# Telis Soliris RTS Hand-held Remote

## FEATURES

UP Button

The MY button acts as a stop button when the window covering is in motion. When the window covering is stationary, the MY button brings it to the programmed favorite position.

DOWN Button

When left LED is lit, the window covering will only react to wind control. When right LED is lit, the window covering will react to both sun and wind control.

Channel Selection Button



Telis 1 Soliris RTS Pure  
Hand-held Remote  
1810635

*Telis 4 Soliris RTS also available*

Patio option  
also available;  
shock and water  
resistant.



Programming  
Button (recessed)



Back view  
of remote

# Telis RTS Modulis Hand-held Remote

## FEATURES



- Channel 1
- Channel 2
- Channel 3
- Channel 4
- Channel 5

Telis 4 Modulis RTS  
5 Channel Pure  
Hand-held Remote  
1811235

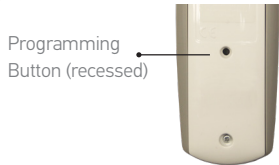

Back view  
of remote

# Telis 16 Channel RTS Hand-held Remote

## FEATURES

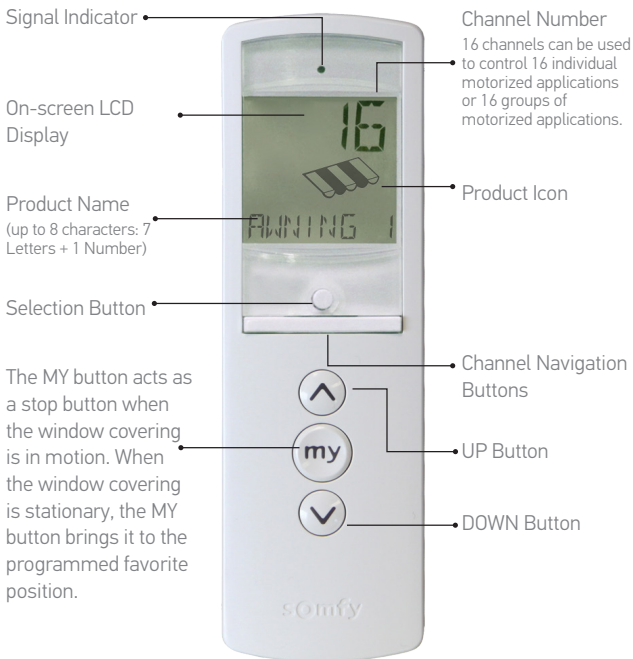

Telis 16 RTS Pure  
16 Channel Hand-held Remote  
1811081



Also available  
in Silver finish

Programming  
Button (recessed)



Back view of remote

**NOTE: The Telis 16 channel remote features an LCD screen that numerically displays what channel is selected.**

**Programming  
Instructions pg.132**

# Telis 1 Chronis RTS Hand-held Remote

## FEATURES

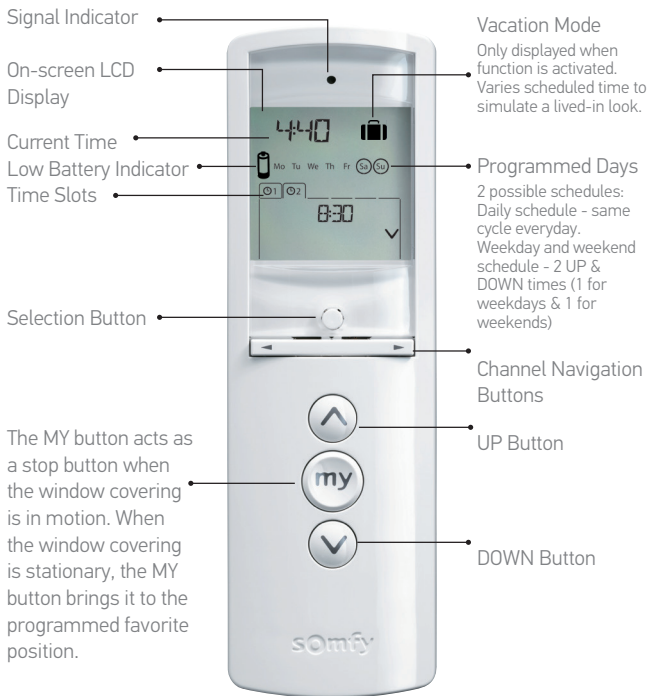

Telis 1 Chronis RTS Pure  
Hand-held Remote  
1805237

Programming  
Button (recessed)



Back view of remote

**Programming  
Instructions pg.134**

# Smooove® 1 RTS Wall Switch

## FEATURES

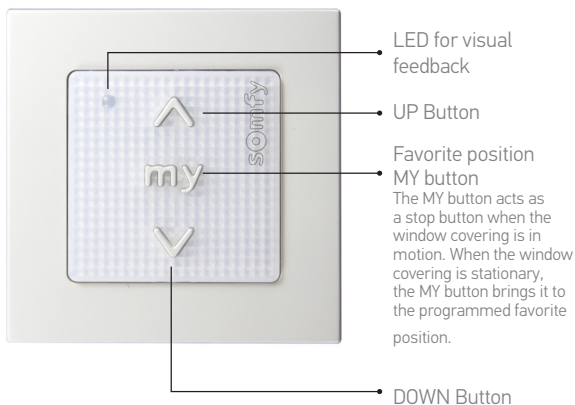

Smooove® 1 RTS Pure Wireless Wall Switch  
1811533

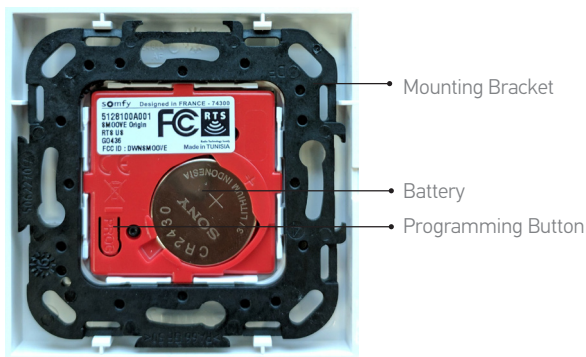

Back view

Additional frame options:



# DecoFlex WireFree™ RTS Wall Switch

## FEATURES

LED for each channel. Available in 1, 2, 3, 4 and 5 channel versions.

Channel Buttons  
Can be custom engraved for easy organization.

STOP Button  
stops the window covering when it's in motion. When the window covering is stationary, the STOP button brings it to the programmed favorite position.

Programming Button  
(recessed)

UP and DOWN  
Command Buttons

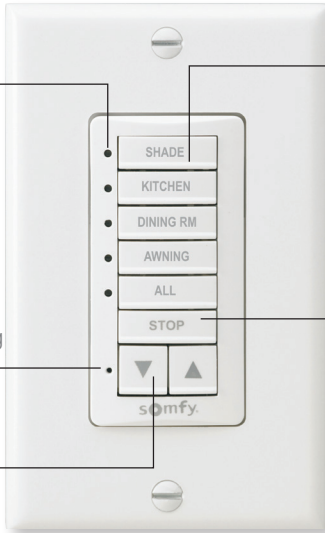

5 Channel Button DecoFlex WireFree™  
RTS Wall Switch shown in White  
1810813



Also available in  
Ivory and Black  
1 - 5 channels

## INSTALLER TIP

**CONTROL ALL** without  
creating an **ALL** channel.

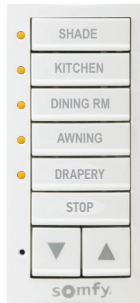

Press the channel buttons you wish to control (LED's light up) prior to pressing UP, DOWN or STOP. ALL selected channels will operate in a cascading fashion.

# DecoFlex WireFree™ RTS Table Top Accessory

## FEATURES

LED for each channel.  
Available in 1, 2,  
3, 4 and 5 channel  
versions.

Custom Engraved  
Channel Buttons

Programming Button  
(recessed)

UP and DOWN  
Command Buttons



STOP button  
stops the window  
covering when  
it's in motion.  
When the window  
covering is  
stationary, the  
STOP button  
brings it to the  
programmed  
favorite position.



Side view

DecoFlex WireFree™  
RTS Table Top Accessory  
Silver 1810972

Ergonomically designed for  
comfortable hand-held use.  
Features rubber non-slip feet.

Also available:



White  
1811185



Black  
1811051

## INSTALLER TIP

**CONTROL ALL** without  
creating an ALL channel.



Press the channel  
buttons you wish to  
control (LED's light  
up) prior to pressing  
UP, DOWN or STOP.  
ALL selected  
channels will  
operate in a  
cascading fashion.



# Outdoor Lighting Receiver RTS

## FEATURES

- Control patio or deck lights with the same remote used for the awning.
- Controls incandescent, halogen light or any outdoor device up to 500W.
- Fully compatible with the Telis RTS range of transmitters and the DecoFlex Wirefree™ RTS wall switches.



Outdoor Lighting Receiver RTS  
1810875

Weatherproof cover with watertight strain-relief fittings for wires

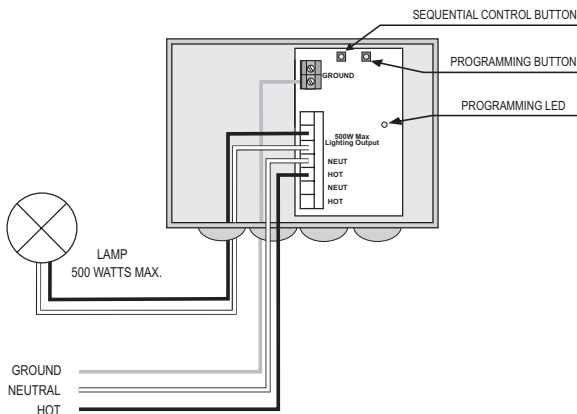

**Programming  
Instructions pg. 98**

# Outdoor Universal RTS Receiver

## FEATURES

- Provides RTS capability to Somfy's standard motors.
- Can be used with RTS controls and/or sensors.
- Two user-defined intermediate positions can be programmed.



Outdoor Universal  
RTS Receiver  
1810627

Weatherproof cover with watertight strain-relief fittings for wires

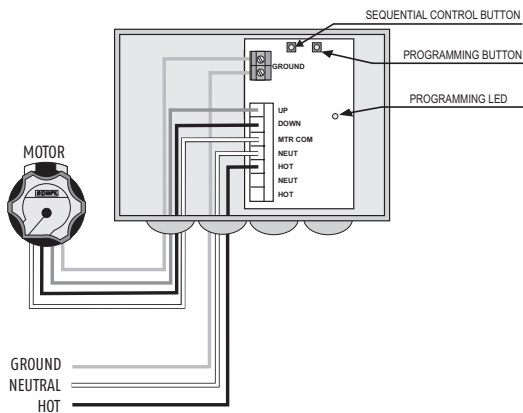

Programming  
Instructions pg.99

# Dimmable LED RTS Light Kit

## FEATURES

- Completely plug-and-play, no electrician required.
- 12 levels of brightness.
- "My" position, favorite light brightness level.
- Up to 60W of 12V DC LED lighting (daisy chain of 6 LED strips).
- Compatible with full range of RTS hand-held remotes, wall switches and Somfy myLink™ app.
- Ideal for new and existing installations.



LED 12V Light Control Kit Warm White 1811491  
LED 12V Light Control Kit Cool White 1811506

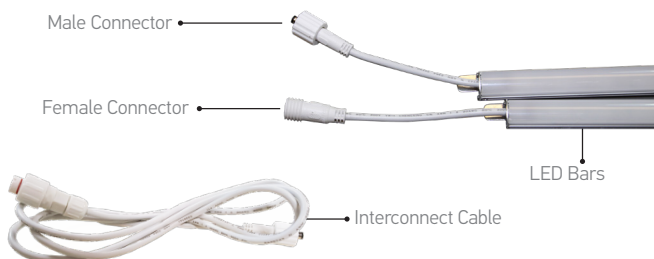

**Programming  
Instructions pg.100**

# Universal RTS Interface (URTSI)

## FEATURES

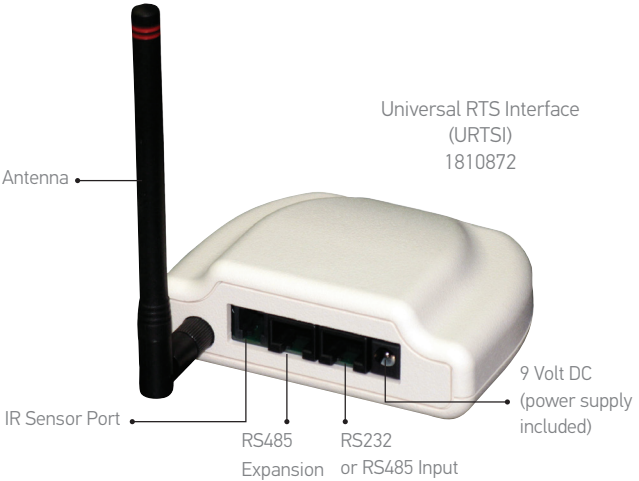

- Allows user to convert infrared, RS232 and RS485 protocol into Radio Technology Somfy® (RTS) to allow for third party control.
- Offers 16 channels.
- Compatible with full range of RTS motors.
- With its compact and sleek design, the URTSI can be housed in a discreet location.

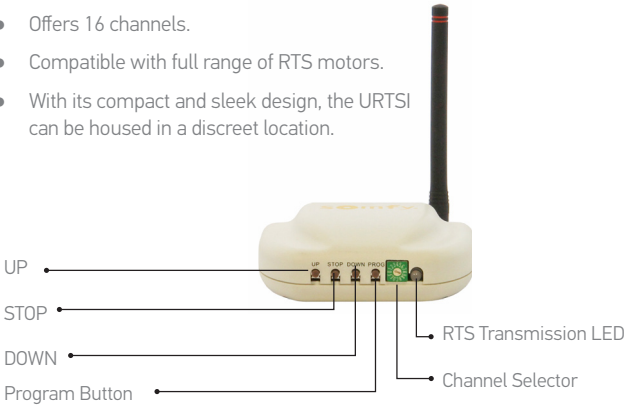

**Programming  
Instructions pg.105**

# Somfy myLink™ Smartphone/Tablet Interface

## FEATURES

The Somfy myLink™ offers convenient control of any Radio Technology Somfy® (RTS) motorized application with a smartphone or tablet.

It consists of a simple plug-in device and free app that transforms the experience that users have with their motorized applications.

### LED Indicator States -

1. Solid Red: setup mode (out of the box)
  - a. Re-engage by pressing programming button on the side
2. Solid Green: connected to LAN
3. Slow Blinking Green: searching for network
4. Quick Red Flash: sending RTS command
5. Solid Amber: failsafe mode

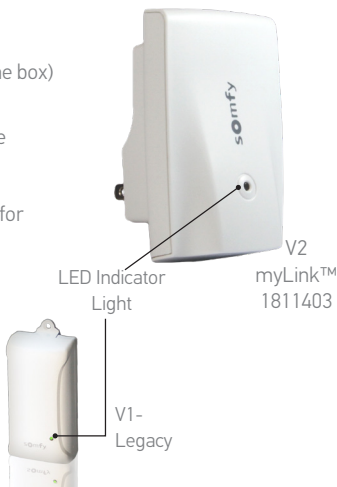

### App Status Indicator -

White O: mobile device can connect to the myLink(s) and commands are being sent over the local WiFi network.



White O with Sight: mobile device can connect to the myLink(s) and commands are being sent over the internet.



White O with !: the mobile device cannot connect to a myLink/myLinks.



**Programming  
Instructions pg.105**

# RTS Repeater

## FEATURES

The RTS Repeater receives the signal from a Telis RTS remote or DecoFlex WireFree™ RTS wall switch or similar device and re-transmits the signal to an RTS compatible motor or receiver to extend the RTS range.

Antenna

Indicator Light



RTS Repeater  
1810791

- Simply plugs into any 120V AC electrical outlet.
- No programming required.
- Should be placed approximately halfway between the transmitting device such as a Telis hand-held remote and the receiving device, the motor.
- Solves the challenge of transmitting the signal in particularly large rooms or areas.
- 1 per job, with a range up to 60 feet in optimal condition. The range may vary depending on site conditions.

**Programming  
Instructions pg.105**

# Sunis Indoor WireFree™ RTS Sensor

## FEATURES

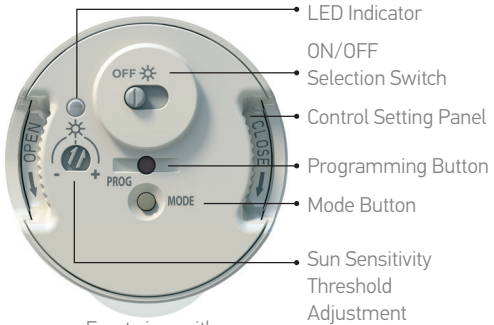

Front view with cover removed  
 Sunis Indoor WireFree™  
 RTS Sun Sensor  
 9013707

The Sunis Indoor Sensor can be programmed to automatically adjust window coverings in accordance to sunlight threshold settings.



Window Sill Mount



Window Mount



Suction cup for mounting on window sill or window



Back view with light sensing eye

**Programming  
 Instructions pg.111**

# Thermo Sunis Indoor WireFree™ RTS Sensor

## FEATURES

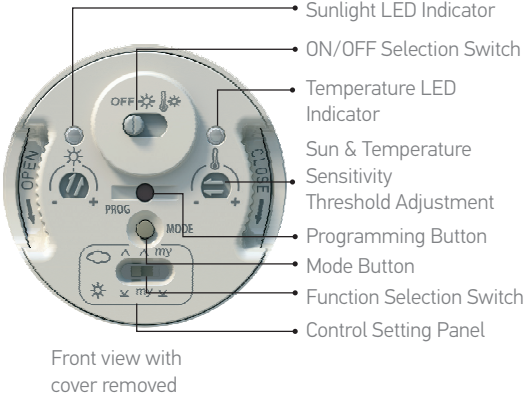

ThermoSunis Indoor WireFree™  
RTS Sun and Temperature Sensor  
9013708

The Thermo Sunis Indoor Sensor can be programmed to automatically adjust window coverings in accordance to sunlight and/or room temperature threshold settings.



Window Sill Mount



Window Mount



Suction cup for mounting on window sill or window



Back view with light sensing eye

**Programming  
Instructions pg.116**



# Sunis Outdoor WireFree™ RTS Sun Sensor

## FEATURES



Front view

Sunis Outdoor WireFree™ RTS  
Sun Sensor  
9020412

- Totally wireless sun sensor for automatic control of exterior RTS motorized awnings, screens, shutters and pergolas
- Easily adjustable sunlight thresholds
- Powered by 2 standard AA alkaline batteries
- Simple installation
- Demo mode for testing settings without delays
- LEDs for visual status updates

The Sunis Outdoor Sensor can be programmed to automatically control exterior RTS motorized awnings, screens, shutters and pergolas based on sunlight levels. Easily adjustable with 8 levels of sun threshold settings.

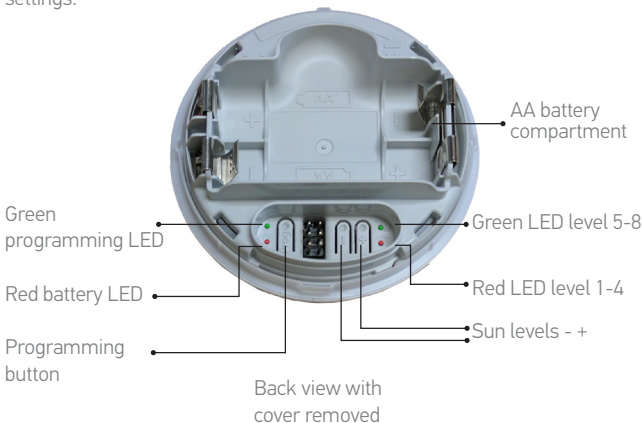

**Programming  
Instructions pg. 121**

# Eolis 3D WireFree™ RTS Wind Sensor

## FEATURES



Eolis 3D WireFree™ RTS  
(White finish)  
1816081

- Installed discreetly on the end of the front bar.
- Easy wireless installation.
- Automatically retracts the awning with the detection of wind generated movements.
- Easy to program.
- Maintenance free, long-life batteries.

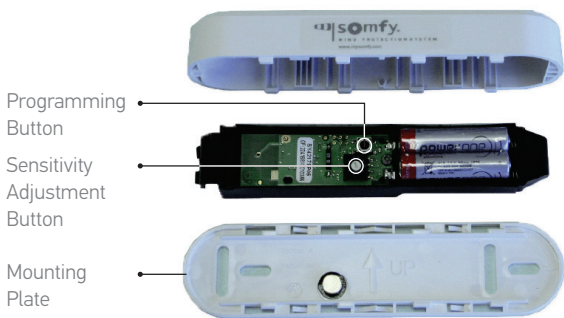

Also available in:  
Off-white - 1816083  
and Black - 1816082

**Programming  
Instructions pg.123**

# Ondeis® WireFree RTS Rain & Sun Sensor

## FEATURES

- Combination rain and sun sensor
- Control one channel of Radio Technology Somfy® motorized products
- Solar powered rechargeable battery
- Adjustable rain and sun thresholds
- Wireless installation with flexible mounting options:
  - Six available modes of operation:
    - Awning Rain (default)
    - Awning Sun (requires Telis Soliris Transmitter)
    - Awning Rain & Sun (requires Telis Soliris Transmitter)
    - Shutter/Screen Rain
    - Shutter/Screen Rain & Sun
    - Shutter/Screen Rain & Auto Up
- Demo mode for testing configurations
- 2 easy-to-read LED indicator lights



Ondeis® WireFree RTS  
Rain & Sun Sensor  
9019617

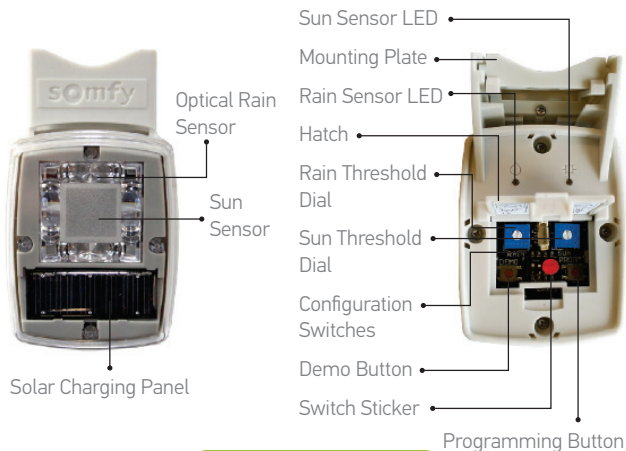

**Programming  
Instructions pg.126**

# Understanding Control Options

Individual .....	25
Group Control .....	26
Individual & Group Control.....	27



# UNDERSTANDING CONTROL OPTIONS: INDIVIDUAL CONTROL

Applies to all Telis RTS Hand-held remotes.

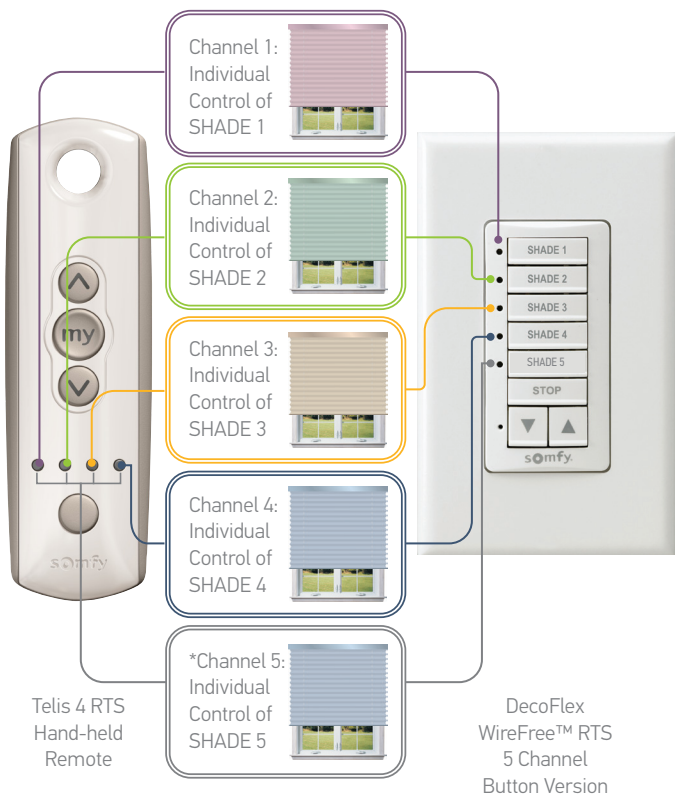

\*Fifth channel is activated when all 4 LEDs illuminate



The Telis 16 channel remote features an LCD screen that numerically displays which channel is selected and provides the option to name each channel.

# UNDERSTANDING CONTROL OPTIONS: GROUP CONTROL

Applies to all Telis RTS Hand-held remotes.

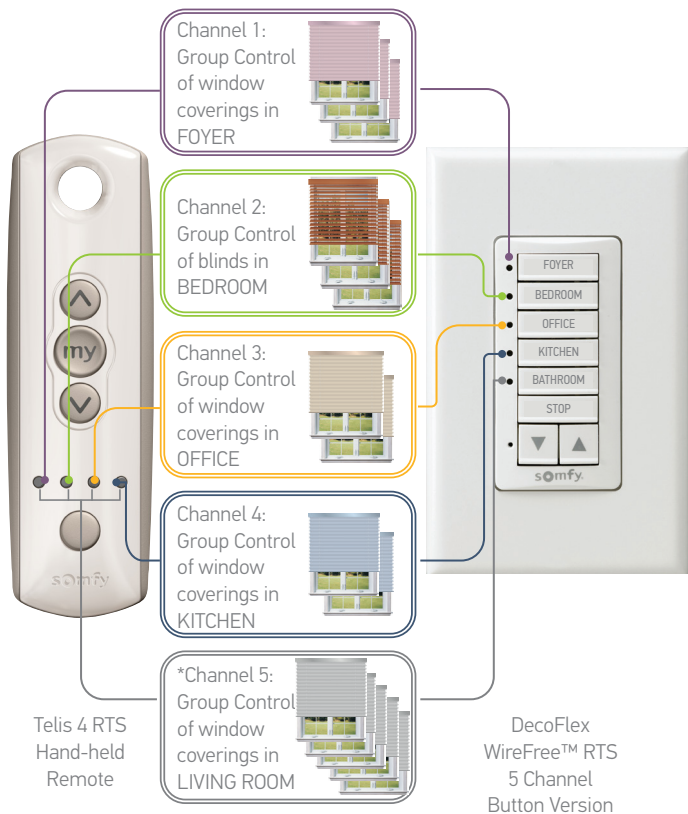

\*Fifth channel is activated when all 4 LEDs illuminate



The Telis 16 channel remote features an LCD screen that numerically displays which channel is selected and provides the option to name each channel.

# UNDERSTANDING CONTROL OPTIONS: INDIVIDUAL & GROUP CONTROL

Applies to all Telis RTS Hand-held remotes.

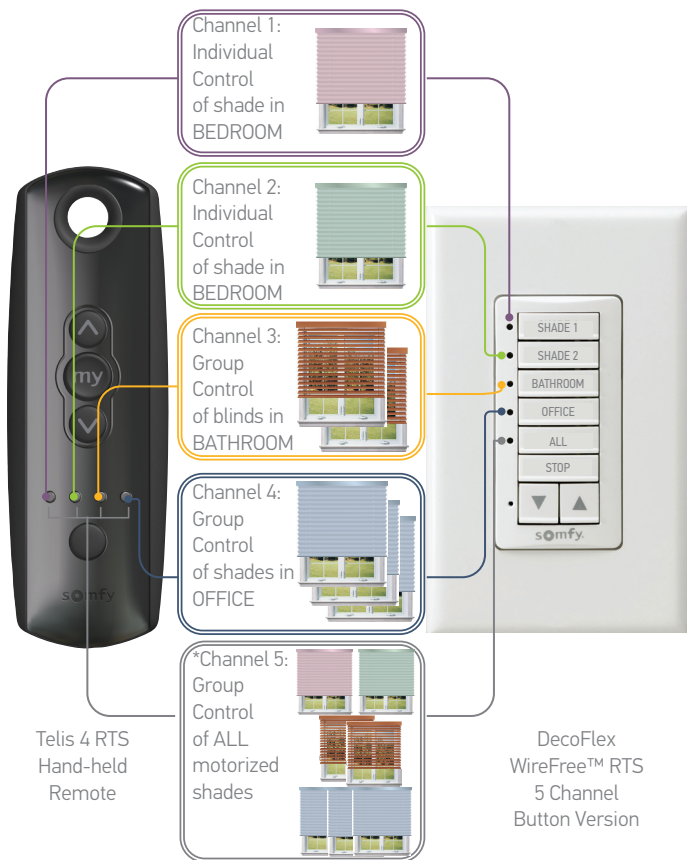

\*Fifth channel is activated when all 4 LEDs illuminate



The Telis 16 channel remote features an LCD screen that numerically displays which channel is selected and provides the option to name each channel.

# INTERIOR PRODUCT APPLICATION AND



WIREFREE™ MOTOR LINE



ULTRA QUIET MOTOR LINE  
- DESIGNED FOR SILENCE



ROLLER  
SHADES



ROMAN/WOVEN  
SHADES

12 V DC	CL32 CORD LIFT WIREFREE™			✓
	TILT 50 WIREFREE™			
	R28 ROLL UP WIREFREE™		✓	✓
	ROLL UP 28 WIREFREE™		✓	✓
12 V DC Built-in Li-ion Battery	ROLL UP 24 and 28 WIREFREE™ LI-ION		✓	✓
	SONESSE® 28, 30 and 40 WIREFREE LI-ION		✓	✓
	SONESSE® 30 ULTRA WIREFREE LI-ION		✓	✓
24 V DC	ST30 SONESSE® 30		✓	✓
	SONESSE® ULTRA 50 DC		✓	✓
	IRISMO™ 35 MINI DC			
26.5 V DC	IRISMO™ 45 WIREFREE			
120 V	ST40 SONESSE® 40		✓	✓
	ALTUS® 40		✓	✓
	ST50 SONESSE® 50		✓	✓
	SONESSE® ULTRA 50 AC		✓	✓
	ALTUS® 50 RTS CMO		✓	✓
	GLYDEA® 35e			
	GLYDEA® 60e			
	GLYDEA® ULTRA			



# MOTOR COMPATIBILITY CHART



SHEER HORIZONTAL/  
LAYERED SHADES



2" WOOD  
BLINDS



PLEATED/  
CELLULAR  
SHADES



DRAPERIES

		✓	
	✓		
✓	✓		
✓	✓		
✓	✓		
✓	✓		
✓	✓		
✓	✓	✓	
			✓
			✓
✓	✓ Using CTS 40	✓	
	✓		
	✓		
	✓		
			✓
			✓
			✓

# EXTERIOR PRODUCT APPLICATIONS AND MOTOR COMPATIBILITY CHART



AWNINGS



ROLLING  
SHUTTERS



EXTERIOR  
SOLAR  
SCREENS

120 V	ALTUS® 40	✓	✓	✓
	ALTUS® 50 RTS CMO	✓	✓	✓
	LT50 RTS CMO	✓	✓	✓
	SUNEA	✓		✓
	OXIMO™		✓	
	ALTUS® 60	✓	✓	
	MAESTRIA™ 50			✓

# Programming Guides



# Getting Started

Steps vary based on the mode of the motor, so take a few minutes to become familiar with the various modes covered in the guide.

**FACTORY MODE** is when the shade/blind is not programmed at all, no limits are set and it is not paired with any type of a control device (transmitter, wall switch, myLink™ etc.). The motor is in this default mode prior to fabrication of the shade, blind, screen, awning etc...

After resetting the motors to factory mode, all motor limits will need to be re-established. Please refer to appropriate programming instructions.

The motor doesn't react to any commands from a transmitter or sensor.

**PROGRAMMING MODE** is the process when the following steps occur:

- Setting of limits
- Adjusting limits
- Pairing a window covering, awning, screen or shutter to a control device(s).

In this mode the motor reacts to the commands from a transmitter in a **momentary fashion** - the UP and DOWN buttons need to be continuously held. Releasing the buttons stops the motor.

In programming mode the radio reception of the motor is reduced. Keep the transmitter closer to the motor head during this time.

**USER MODE** refers to shade/blind ready for consumer use with the limits set and programmed control devices.

In user mode the motor reacts to commands from a transmitter in a **maintained fashion**. Pressing the UP or DOWN buttons moves the motorized product directly to the respective limit.

MY/STOP - stops the product when it is in motion. When stationary the MY/STOP sends the product to the preferred "my" position (if it was set).

# CONTROL DEVICES ILLUSTRATIONS & GLOSSARY

The following illustrations and instructions represent the Telis hand-held remote and may also be applied to the DecoFlex WireFree™ RTS Switch and Smoove® Wall Switch.

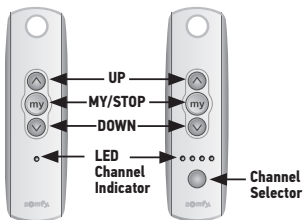

Telis 1  
RTS Transmitter

Telis 4  
RTS Transmitter

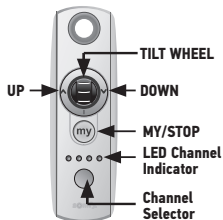

Telis 4 Modulis  
RTS Transmitter

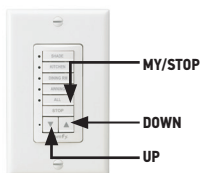

DecoFlex WireFree™  
RTS Switch (Standard)

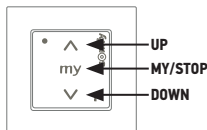

Smoove® 1 RTS Wall  
Switch



Types of button presses during programming:

**PRESS & HOLD** - until something happens - usually a jog

**BRIEF PRESS** - the motor jogs upon release of the button(s).



A JOG IS A BRIEF UP & DOWN OR IN & OUT  
MOVEMENT

## STANDARD QUICK PROGRAMMING FOR RTS MOTORS

- CL32 CORD LIFT WIREFREE™
- R28 Roll Up WireFree™
- R28 Roll Up WIREFREE™
- ROLL-UP 28 WireFree™ RTS
- ST30 SONESSE® 30
- ST40 SONESSE® 40
- ALTUS® 40
- ST50 SONESSE® 50
- SONESSE® ULTRA 50
- ALTUS® 50
- ALTUS® 60

### CL32 CORD LIFT WIREFREE™- BATTERY OR TRANSFORMER POWERED



Side view

12V DC



PLEATED/CELLULAR SHADES



ROMAN/WOVEN SHADE

### R28 ROLL UP WIREFREE™ RTS-BATTERY OR TRANSFORMER POWERED



30 mm motor diameter



Side view

12V DC



ROLLER SHADE



ROMAN/WOVEN SHADE



SHEER HORIZONTAL SHADE

### ROLL-UP 28 WIREFREE™ RTS-BATTERY OR TRANSFORMER POWERED



30 mm motor diameter



V1 style head

12V DC



ROLLER SHADE



ROMAN/WOVEN SHADE



SHEER HORIZONTAL SHADE

## STANDARD QUICK PROGRAMMING FOR RTS MOTORS

ST30 SONESSE® 30 RTS - TRANSFORMER OR LOW VOLTAGE HARDWIRED



30 mm motor diameter

Side view

24V DC



ROLLER SHADE



ROMAN/WOVEN  
SHADE



2" HORIZONTAL  
BLIND



SHEER HORIZONTAL  
SHADE



PLEATED/CELLULAR  
SHADES

ST40 - SONESSE® 40 RTS - HARDWIRED OR PLUG-IN



40 mm motor diameter

Side view

120V AC



ROLLER SHADE



ROMAN/WOVEN  
SHADE



2" HORIZONTAL  
BLIND



SHEER HORIZONTAL  
SHADE



PLEATED/CELLULAR  
SHADES

SONESSE® ULTRA 50 DC RTS - TRANSFORMER OR LOW VOLTAGE HARDWIRED



50 mm motor diameter



Side view

24V DC



ROLLER SHADE



ROMAN/WOVEN  
SHADE

\*Please note: If you cannot identify the motor or control being used, please contact Somfy customer service at 877-22 SOMFY

## STANDARD QUICK PROGRAMMING FOR RTS MOTORS

### ALTUS® 40 - HARDWIRED OR PLUG-IN



40 mm motor diameter



Side view

120V AC



AWNING



ROLLING SHUTTER



2" HORIZONTAL BLIND



ROMAN/WOVEN SHADE



EXTERIOR SOLAR SCREENS



ROLLER SHADE

### ST50 SONESSE® 50 RTS - HARDWIRED OR PLUG-IN



50 mm motor diameter



Side view

120V AC



ROLLER SHADE



ROMAN/WOVEN SHADE



2" HORIZONTAL BLIND

### SONESSE® ULTRA 50 AC RTS - HARDWIRED OR PLUG-IN



50 mm motor diameter



Side view

120V AC



ROLLING SHUTTER



ROMAN/WOVEN SHADE



# STANDARD QUICK PROGRAMMING FOR RTS MOTORS

## ALTUS® 50 - HARDWIRED OR PLUG-IN



50 mm motor diameter



Side view

120V AC



AWNING



ROLLING SHUTTER



2" HORIZONTAL BLIND



ROMAN/WOVEN SHADE



EXTERIOR SOLAR SCREENS



ROLLER SHADE

## ALTUS® 60 - HARDWIRED OR PLUG-IN



60 mm motor diameter



Side view

120V AC



AWNING



ROLLING SHUTTER

\*Please note: If you cannot identify the motor or control being used, please contact Somfy customer service at 877-22 SOMFY

## STANDARD QUICK PROGRAMMING FOR RTS MOTORS

- CL32 CORD LIFT WIREFREE™
- ROLL-UP 28 WIREFREE™
- ST30 SONESSE® 30
- ST40 SONESSE® 40
- ALTUS® 40
- ST50 SONESSE® 50
- SONESSE® ULTRA 50
- ALTUS® 50
- ALTUS® 60

*\*Additional settings (sleep mode and speed adjustment) are available for the Roll-Up 28 WireFree™ RTS motor. For instructions see page 43.*

## FACTORY MODE

**STOP** BEFORE YOU BEGIN: Motors are shipped in **factory mode**, without set limits or programmed transmitters.

**!** *Note - If motor is 120V AC hardwired and cannot be disconnected, please contact an electrician prior to calling Somfy customer service for assistance.*

## CONNECT THE MOTOR TO POWER

With the motor installed in window covering, connect power only to the motor being programmed (120V AC, or 12V DC or 24V DC transformer or 12V battery wand).

### FOR ROLL-UP 28 WIREFREE™ RTS motors:

Wake up the motor by **BRIEFLY PRESSING** the motor head **PROGRAMMING BUTTON** or plug in the charger.

The shade will briefly jog three times.



## PROGRAMMING MODE

**!** *While programming, the motor should not be inactive for more than 2 minutes or it will exit programming mode. Roll-up 28 motor will return to sleep mode after 15 minutes of inactivity.*

### STEP 1: INITIATE PROGRAMMING

On the transmitter, **PRESS & HOLD** both the **UP** and **DOWN** simultaneously until the motor jogs.



A jog is a brief up and down or in and out motion.

In **programming mode**, the window covering will move only when the **UP** or **DOWN** is held (momentary fashion).

## STANDARD QUICK PROGRAMMING FOR RTS MOTORS

### STEP 2: CHECK THE DIRECTION OF OPERATION

 During installation, it is mandatory to test and verify the motorized window covering operates in accordance to the commands from the hand-held transmitter.

If the control direction is not properly programmed, sensors will not function in the manner they are intended.

**PRESS & HOLD** the **DOWN** button. The shade should go down or out.



If window covering does not correspond with UP or DOWN REVERSE the direction. Simply **PRESS & HOLD** the **MY/STOP** until the window covering jogs. Confirm before proceeding.



### STEP 3: SETTING LIMITS (The end limits can be set in any order)

#### Setting the Upper Limit

1) Bring the window covering to desired UPPER limit position.

2) **PRESS & HOLD** both **MY/STOP** and **DOWN** simultaneously until the application starts to move, then release. If the window covering stops when the buttons are released, take it back to the UPPER limit and repeat.

3) Stop the motor when desired LOWER limit is reached. Adjust by pressing UP or DOWN if necessary.

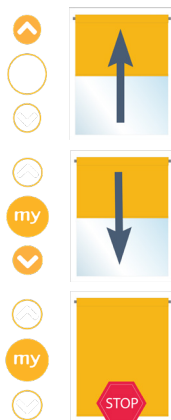



## STANDARD QUICK PROGRAMMING FOR RTS MOTORS

### Setting the Lower Limit

4) **PRESS & HOLD** both **MY/STOP** and **UP** simultaneously until the application starts to move, then release.

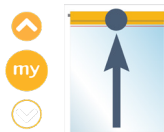
The window covering will stop at the previously set UPPER limit.



 *In case of problems with setting of limits during **programming mode**, turn the power off to the motor for 2 seconds and then back on to reset the motor. Please return to **programming mode** to initiate programming process.*

### Confirming Limit Settings

5) **PRESS & HOLD MY/STOP** until the window covering jogs confirming the limit settings.

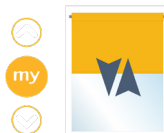

6) **COMPLETE PROGRAMMING BRIEFLY PRESS** the **PROGRAMMING BUTTON** on the back of the transmitter. The window covering jogs and is now in **USER MODE**.



## USER MODE

In **user mode**, the window covering will operate by briefly pressing the UP or DOWN (maintained fashion).

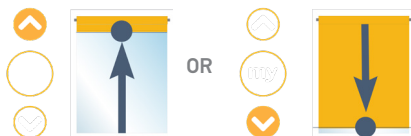

## STANDARD QUICK PROGRAMMING FOR RTS MOTORS

### ADJUSTING LIMITS IN USER MODE

#### To Change the Lower Limit

**STEP 1:** Press **DOWN** to send the window covering to its current LOWER Limit.

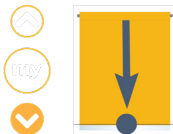

**STEP 2:** **PRESS & HOLD** both **UP** and **DOWN** simultaneously until the window covering jogs. Adjust to a new LOWER limit position.

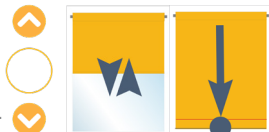

**STEP 3:** **PRESS & HOLD MY/STOP** until the window covering jogs, to confirm new limit.

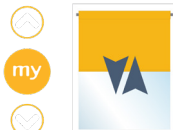

#### To Change the Upper Limit:

**STEP 1:** **BRIEFLY PRESS UP** to send the window covering to its current UPPER Limit.

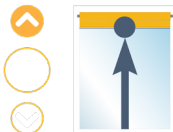

**STEP 2:** **PRESS & HOLD** both **UP** and **DOWN** simultaneously until the window covering jogs. Adjust to a new UPPER limit position.

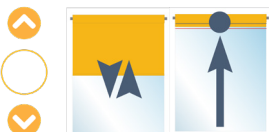

**STEP 3:** **PRESS & HOLD** the **MY/STOP** button until the window covering jogs, confirming the new limit.

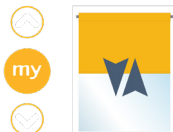

### SETTING INTERMEDIATE PREFERRED "MY" POSITION

Using the UP and DOWN buttons send the window covering to the desired intermediate "my" position. Once it is reached, **BRIEFLY** press **MY/STOP** to stop the shade and then **PRESS & HOLD MY/STOP** until a jog - confirming the "my" position.

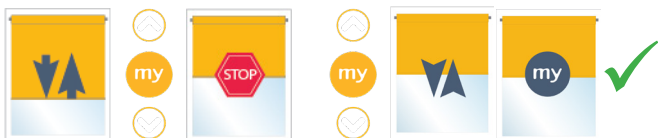

## STANDARD QUICK PROGRAMMING FOR RTS MOTORS

### Activating the "my" Position

Send the window covering to the "my" position by pressing **MY/STOP** from ANY window covering position.

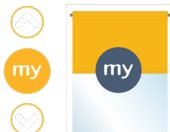

**!** Window covering should be stationary prior to activating "my" position function. If window covering is actively moving (in-motion), MY/STOP should be pressed twice.

### Deleting or Adjusting the "my" Position

**BRIEFLY PRESS MY/STOP** to send the window covering to the current "my" position, then **PRESS & HOLD** the **MY/STOP** button for 5 seconds. Window covering will jog to confirming deletion of "my" position.

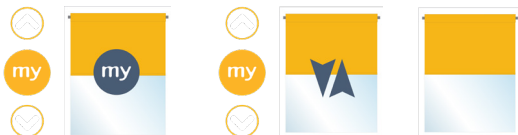

## ADDING OR DELETING CHANNELS OR CONTROLS

The procedure for adding or deleting an RTS control is the same.

**STEP 1: PRESS & HOLD** the **PROGRAMMING BUTTON** on **CONTROL 1** until the window covering jogs.

**STEP 2: BRIEFLY PRESS** the **PROGRAMMING BUTTON** on **CONTROL 2**. The window covering jogs.

**!** Step 1 should not be performed with control intended for deletion.



### CONTROL 1

Previously programmed control - single channel or the channel (1-5) of a multi-channel control.



### CONTROL 2

Second control to be added or deleted - single channel or the channel (1-5) of a multi-channel control.

# ADDITIONAL SETTINGS ONLY FOR THE NEW ROLL-UP 28 WIREFREE™ MOTORS

## ADJUSTING THE SPEED

 LED blinks alternately in green and orange.



1) Move the shade away from the end limits.

**PRESS & HOLD** the **UP, MY/STOP** and **DOWN** simultaneously, until the shade jogs.

The shade will move up and down automatically in ten second cycles.



2) To increase the speed, **PRESS & HOLD** the **UP** button until the shade jogs. Repeat as needed.

 Maximum speed is achieved when the shade no longer responds to the press of the UP button.

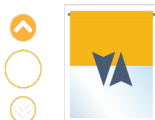

3) To decrease the speed, **PRESS & HOLD DOWN** until the shade jogs. Repeat as needed.

 Minimum speed is achieved when the shade no longer responds to the press of the DOWN button.

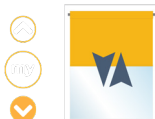

4) To confirm the new speed, **PRESS & HOLD** the **MY/STOP** button until the shade jogs.

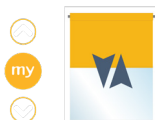

## SLEEP MODE

 The shade must be programmed.

 This feature temporarily prevents the motor from responding to any previously programmed transmitter commands.

### Enabling Sleep Mode

1) **PRESS & HOLD** the motor head **PROGRAMMING BUTTON** until the shade jogs. LED will blink green.

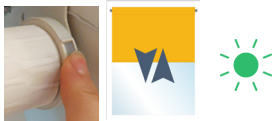

2) **BRIEFLY PRESS** the motor head **PROGRAMMING BUTTON**, the shade jogs twice. LED stops. "Sleep Mode" is activated.



### Disabling Sleep Mode

3) Press the motor head **PROGRAMMING BUTTON**. The shade jogs and the transmitter commands are enabled.

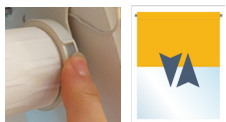

## STANDARD QUICK PROGRAMMING FOR RTS MOTORS

### RESETTING ALL PRE-PROGRAMMED LIMIT SETTINGS & CHANNELS

Using a paper clip or a similar device, **PRESS & HOLD** the **PROGRAMMING BUTTON** (approximately 15 seconds) located on the motor head until window covering jogs 3 times, then release button.

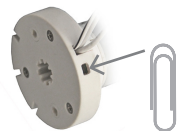

R28 Roll Up WireFree™ RTS  
or LT-30 RTS 12V DC motors

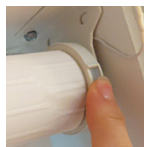

ROLL-UP 28 WireFree™ RTS



ST30 Sonesse® 30 24V DC



CL32 Cord Lift WireFree™  
RTS Motors

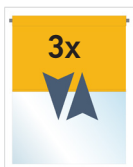

All transmitters and limits will be erased (motor is now reset to **factory mode**). Motor limits will need to be reestablished.

**Please return back to programming mode to initiate programming process.**

### Sonesse® Ultra 50 DC Motors



In addition to programming via transmitter, Sonesse® Ultra motor head buttons (UP, DOWN and STOP) also allow setting and controlling the motor directly on the motor head without any control devices or tools.

Using the buttons you can:

- modify the end limits
- pair/unpair additional transmitters
- lock/unlock the receiver
- reset the motor settings



## STANDARD QUICK PROGRAMMING FOR RTS MOTORS

### RESETTING ALTUS® RTS 110V AC TO FACTORY MODE

#### Resetting All Pre-Programmed Limit Settings & Channels

Perform a Dual Power Cut to delete all previous settings and return motor to factory mode.



Remove plug from power for 2 seconds.



Plug in power cord for 10 seconds.



Remove plug from power for 2 seconds.



Plug in power cord. The motor will begin to move for about 5 seconds if the motorized product is away from the limits and jog if at a limit.

When the window covering stops, **PRESS & HOLD** the **PROGRAMMING BUTTON** of any transmitter until the window covering **jogs twice**. **Do not release the PROGRAMMING BUTTON** until the jogging is complete or you will have to start the dual power cut from the beginning.



**PRESS & HOLD**  
for about  
7 seconds



The motor will jog after  
about 2 seconds.  
Keep holding.



And then the motor  
will jog again  
validating the reset.

## QUICK PROGRAMMING FOR RTS MOTORS WITH EMBEDDED LI-ION BATTERIES



- Roll Up 24 WireFree™ (Li-ion),
- Sonesse® 28 WireFree (Li-ion),
- Roll Up 28 WireFree™ (Li-ion),
- Sonesse® ULTRA 30 WireFree (Li-ion),
- Sonesse® 30 WireFree (Li-ion),
- Sonesse® 40 WireFree (Li-ion)

12V DC



ROLLER SHADE



ROMAN/WOVEN  
SHADE



2" HORIZONTAL  
BLIND



SHEER HORIZONTAL  
SHADE

## QUICK PROGRAMMING FOR RTS MOTORS WITH EMBEDDED LI-ION BATTERIES



### BEFORE YOU BEGIN

Motors are shipped in **factory mode**, without set limits or programmed transmitters.



**ENSURE THE BATTERY IS CHARGED BEFORE PROCEEDING.**

**NOTE:** Some older motors may have the V1 style head



V1 Style head



V2 Style Head



Orange LED blinks continuously - the motor is in programming mode.



Green LED blinks once when any order from a paired remote is received. Blinks 5 times when step is memorized.



Red LED blinking 5 times indicates low battery, plug in the charger. Solid red LED indicates obstacle.

Continuously blinking red LED indicates thermal protection mode - wait for the motor to cool down.

# QUICK PROGRAMMING FOR RTS MOTORS WITH EMBEDDED LI-ION BATTERIES

## STEP 1: COMMISSIONING - WAKE UP THE MOTOR

**BRIEFLY PRESS** the motor head **PROGRAMMING** **BUTTON** or plug in the charger. The shade will briefly jog three times.



 **To avoid accidental programming of drive(s) once awake, follow section “Activate/Deactivate RTS” when control point is temporarily preprogrammed (not paired) to the window covering to deactivate RTS.**

## STEP 2: INITIATE PROGRAMMING

**PRESS & HOLD** the **UP and DOWN** buttons simultaneously: the shade jogs.

**NOTE:** Make sure the motor is not inactive for more than 2 minutes, or it will exit programming mode.

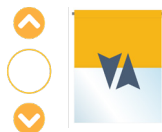

## STEP 3: CHECK THE ROTATION DIRECTION

**NOTE: Must be determined before setting the limits**

**PRESS & HOLD** the **DOWN** button and confirm the shade moves down.

If the direction is correct, continue to Step 4.



If the direction is not correct (in reverse) and the shade goes up when pressing DOWN, **PRESS & HOLD** the **MY/STOP** button on the transmitter for about 2 seconds until the shade jogs.



Confirm the correct direction before proceeding.

# QUICK PROGRAMMING FOR RTS MOTORS WITH EMBEDDED LI-ION BATTERIES

## STEP 4: SETTING LIMITS

(The end limits can be set in any order)

### Setting the Upper Limit

1) Move the shade to the desired upper position. Adjust using the UP or DOWN buttons.

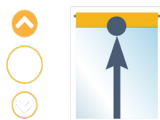

2) **PRESS & HOLD** the **MY/STOP** and **DOWN** buttons simultaneously until the shade begins to move, then release.

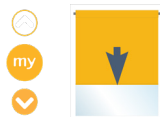

### Setting the Lower Limit

3) Press the **MY/STOP** button when the shade reaches the desired lower position. Adjust using the UP or DOWN buttons.

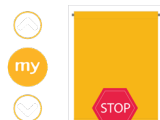

4) Press the **MY/STOP** and **UP** simultaneously and release when the application begins to move.

The shade will stop at the upper limit set in previous steps.

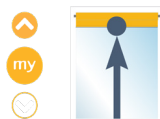

### Confirm Both Limits

5) To confirm limit programming **PRESS & HOLD** the **MY/STOP** button until the shade jogs.

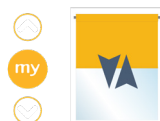

## STEP 5: COMPLETE PROGRAMMING

**BRIEFLY PRESS** the **PROGRAMMING BUTTON** on the back of the control. The window covering will jog to confirm pairing.



The control is now in **user mode**. The window covering will operate by briefly pressing the UP, DOWN or MY/STOP buttons.

# QUICK PROGRAMMING FOR RTS MOTORS WITH EMBEDDED LI-ION BATTERIES

## USER MODE

### DISABLING RTS in USER MODE

 Disabling the radio transmission saves battery life during shipment or for a long period of non-use (eg. storage).

 ***The following steps can only be performed in user mode.***

### TO DEACTIVATE RTS:

1) **PRESS & HOLD** the **PROGRAMMING BUTTON** on previously programmed control or the motor head until the shade jogs. Motor is in programming mode.



2) **PRESS & HOLD** the **UP, MY/STOP** and **DOWN** simultaneously until the shade jogs once.



### ENABLING RTS in USER MODE

#### TO ACTIVATE RTS:

**BRIEFLY PRESS** the motor head **PROGRAMMING BUTTON**. The shade jogs.



### MODIFYING THE MOTOR ROTATION DIRECTION IN USER MODE

1) Move the shade away from the end limits.

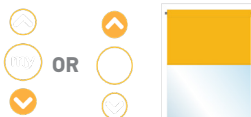

2) **PRESS & HOLD** the **UP** and **DOWN** buttons simultaneously until the shade jogs. LED lights up orange.

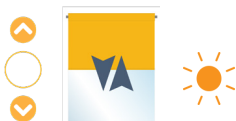

3) **BRIEFLY PRESS** the **MY/STOP** button until the shade jogs to reverse the rotation direction and verify. Yellow LED stops.

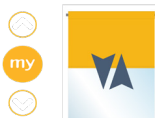

The motor rotation direction is reversed.

# QUICK PROGRAMMING FOR RTS MOTORS WITH EMBEDDED LI-ION BATTERIES

## ADJUSTING LIMITS IN USER MODE

 **Control must be programmed to the shade.**  
 *Green LED lights on for UPPER limit adjustment  
and blinks slowly for LOWER limit adjustment.*



To change the Upper Limit    To change the Lower Limit

1) Move the window covering to its current limit.



2) **PRESS & HOLD** the **UP** and **DOWN** buttons simultaneously until the shade jogs.



3) Adjust the shade to the new position with the UP or DOWN buttons.

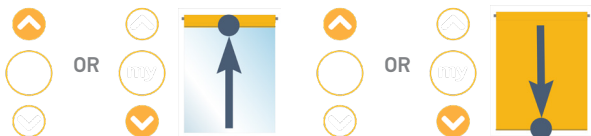

4) To confirm the new position, **PRESS & HOLD** the **MY/STOP** button until the window covering jogs.



# QUICK PROGRAMMING FOR RTS MOTORS WITH EMBEDDED LI-ION BATTERIES

## SETTING INTERMEDIATE "MY" POSITION

1) Move the shade to the desired position and **BRIEFLY PRESS** the **MY/STOP** button to stop the shade.



2) **PRESS & HOLD** the **MY/STOP** button until the shade jogs. Favorite "my" position is set.

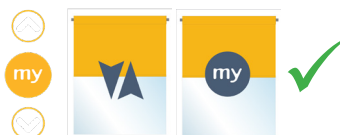

To delete "my" position, first send the shade to the current "my" position then **PRESS & HOLD** the **MY/STOP** button until a jog.

## ADJUSTING THE SPEED

 *LED blinks alternately in green and orange.*



1) Move the shade away from the end limits. **PRESS & HOLD** the **UP, MY/STOP and DOWN** simultaneously, until the shade jogs. The shade will move up and down automatically in ten second cycles.

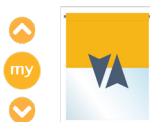

2) To increase the speed, **PRESS & HOLD** the **UP** button until the shade jogs. Repeat as needed.

 Maximum speed is achieved when the shade no longer responds to the press of the UP button.

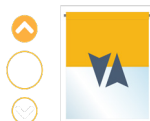

3) To decrease the speed, **PRESS & HOLD** the **DOWN** button until the shade jogs. Repeat as needed.

 Minimum speed is achieved when the shade no longer responds to the press of the DOWN button.

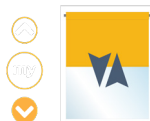

4) To confirm the new speed, **PRESS & HOLD** the **MY/STOP** button until the shade jogs.

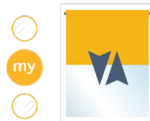

# QUICK PROGRAMMING FOR RTS MOTORS WITH EMBEDDED LI-ION BATTERIES

## MODE SELECTION:

The Sonesse® 30 WireFree RTS is designed to work in 2 modes:



### ROLLER MODE (default)

Yellow LED light is solid



ROLLER SHADE

### or TILTING MODE

Yellow LED blinks slowly



SHEER/ LAYERED  
SHADES



HORIZONTAL  
BLIND

## CHANGE TO TILTING MODE

1) Move the shade/blind away from the end limits.

2) **PRESS & HOLD** both **UP** and **DOWN** buttons until the shade/blind jogs.

3) **PRESS & HOLD** the **MY/STOP** and **DOWN** buttons simultaneously until the shade/blind jogs.

The motor is now in **tilting mode**.

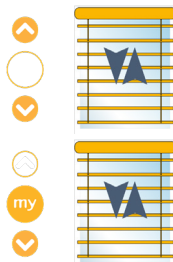

## Modifying the wheel rotation direction using Telis Modulis.

1) Move the blind from the end limits.

2) **PRESS & HOLD** the **UP** and **DOWN** buttons simultaneously until the blind jogs.

3) **PRESS & HOLD** the **UP**, **MY/STOP** and **DOWN** simultaneously, until the blind jogs.

Wheel rotation is reversed.

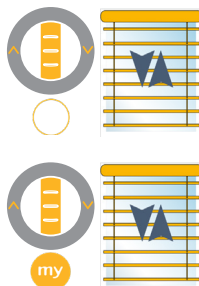



## QUICK PROGRAMMING FOR RTS MOTORS WITH EMBEDDED LI-ION BATTERIES

### ERASING ALL CONTROLS (transmitters) from memory

To delete all the programmed transmitters and sensors, **PRESS & HOLD** the motor head **PROGRAMMING BUTTON** until the shade jogs twice.

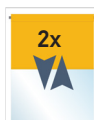

All programmed transmitters are deleted.

### RESETTING THE MOTOR TO FACTORY MODE (erasing all settings)

To reset the motor, **PRESS & HOLD** the motor head **PROGRAMMING BUTTON** until the shade jogs 3 times.



All the settings are erased.  
Limits will have to be re-established.

### SLEEP MODE

 The shade must be programmed.

 This feature temporarily prevents the motor from responding to any previously programmed transmitter commands.

### Enabling Sleep Mode

1) **PRESS & HOLD** the motor head **PROGRAMMING BUTTON** until the shade jogs.

*LED will blink green.*



2) **BRIEFLY PRESS** the motor head **PROGRAMMING BUTTON**, the shade jogs twice. *LED stops.*

**Sleep mode** is activated.

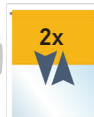

### Disabling Sleep Mode

3) Press the motor head **PROGRAMMING BUTTON**.  
The shade jogs and the transmitter commands are enabled.



## QUICK PROGRAMMING FOR RTS MOTORS WITH EMBEDDED LI-ION BATTERIES

### TIPS AND ADVICE ON INSTALLATION

Question	Possible causes	Solutions
The shade doesn't operate.	The motor battery is low and requires charging.	Charge the battery.
	The control battery is low.	Check the battery and replace if required.
	The control is not compatible or not programmed.	Check the compatibility and replace if needed or program the control.
	The thermal protection has activated.	Wait for the motor to cool down.
The shade stops too soon.	The end limits are incorrectly programmed.	Reset the end limits.
	The shade exceeded the recommended weight limit.	Replace the shade.
	Battery is low.	Charge the battery.
Red LED blinks slowly for 3 sec. before & after motor running.	Battery is low. Battery capacity is 5% or lower.	Charge the battery.

# QUICK PROGRAMMING FOR TILT 50 WIREFREE™ RTS MOTORS

TILT 50 WIREFREE™ BATTERY OR TRANSFORMER POWERED



12V DC



2" HORIZONTAL  
BLIND



Side view

## BEFORE YOU BEGIN

Motors are shipped without limit switch settings and transmitter IDs. Steps (1-5) must be completed to ensure proper shade programming and functionality.

Power should ONLY be connected to the current blind being programmed. All other blinds should be disconnected from their respective power while programming is in progress.



While programming (step 4), shade should not be inactive for longer than 2 minutes or motor will exit programming mode.

The following illustrations and instructions represent the Telis hand-held remote and may also be applied to the DecoFlex WireFree™ RTS Switch and Telis 1 Chronis Timer.



Telis 1  
RTS Transmitter

UP  
MY/STOP  
DOWN  
LED  
Channel  
Indicator



Telis 4  
RTS Transmitter

UP  
MY/STOP  
DOWN  
LED Channel  
Indicator  
Channel  
Selector



Telis 4 Modulus RTS Transmitter  
(with tilt wheel)

UP → DOWN  
MY/STOP  
LED Channel  
Indicator  
Channel  
Selector

# QUICK PROGRAMMING FOR TILT 50 WIREFREE™ RTS MOTORS

## STEP 1: CONNECT POWER TO MOTOR

1) Connect 12V battery wand or transformer to the motor. **Motor should already be installed in the blind.**

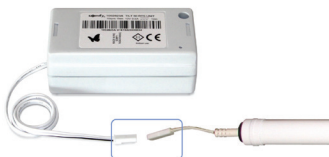

## STEP 2: INITIATE PROGRAMMING

1) On the transmitter (on **Multi-Channel Transmitters** select the desired channel)

**PRESS & HOLD** the **UP** and **DOWN** buttons simultaneously until the blind jogs. (A jog is a short up and down tilt movement).



**NOTE: This step cannot be performed if the transmitter has previously been programmed (paired) to the blind.**

## STEP 3: CHECK POLARITY (BLIND DIRECTION)

**NOTE: Must be determined before setting blind limits**

**PRESS & HOLD** the **DOWN** button and confirm the blind tilts down.

If blind direction is correct, continue to Step 4.

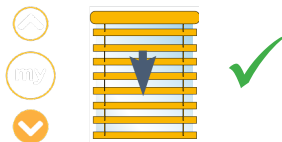

If blind direction is not correct (in reverse), **PRESS & HOLD** the **MY/STOP** button on the transmitter for 2 seconds. Blind will jog.



Confirm the correct blind direction before proceeding.

# QUICK PROGRAMMING FOR TILT 50 WIREFREE™ RTS MOTORS

## STEP 4: SETTING LIMITS (SLAT POSITIONS)

### SETTING LOWER LIMIT

1. Start with the slats in down (closed) position. **PRESS & HOLD** the **UP** or **DOWN** button on the transmitter to reach the desired lower limit (slat position).



2. Once the desired lower limit (slat position) is reached, **PRESS & HOLD** the **MY/STOP and UP** buttons simultaneously until the blind begins to tilt upward, then release.



### SETTING UPPER LIMIT

3. **BRIEFLY PRESS** the **MY/STOP** button when the blind reaches the desired upper limit (slat position). If necessary, adjust the desired slat position with either the UP or DOWN button.

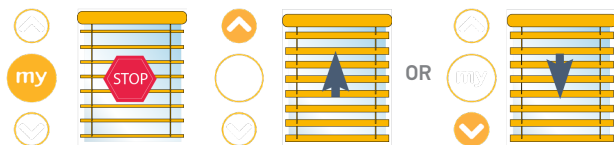

4. Once desired upper limit (slat position) is reached, **PRESS & HOLD** the **MY/STOP and DOWN** buttons simultaneously until the blind begins to tilt downward, then release.



# QUICK PROGRAMMING FOR TILT 50 WIREFREE™ RTS MOTORS

## CONFIRMING BOTH LIMITS

5. Once the blind stops at the previously set lower limit (slat position), **PRESS & HOLD** the **MY/STOP** button for **2 seconds** until the slats jog, confirming both limits (slat positions).



To complete programming, proceed to **STEP 5**.

## STEP 5: COMPLETING AND EXITING PROGRAMMING MODE

**PRESS & HOLD** the **PROGRAMMING BUTTON** on the back of the transmitter or the front of the wall switch until the blind jogs once.

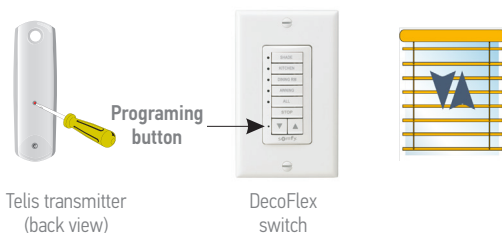

**TRANSMITTER IS NOW MEMORIZED AND PROGRAMMING IS COMPLETE. THE MOTOR IS IN USER MODE.**

**NOTE: If power is disconnected from the blind before Step 5 is completed, THE TRANSMITTER WILL NOT BE MEMORIZED to the programmed blind. However, limits (slat positions) will remain programmed.**

**If this occurs, go back and repeat step 2 (Initiate Programming). Then omit step 4 (Setting Limits) and resume with step 5.**

# QUICK PROGRAMMING FOR TILT 50 WIREFREE™ RTS MOTORS

## USER MODE

### ADDING OR DELETING CHANNELS OR CONTROLS

The procedure for adding or deleting an RTS control is the same.

**STEP 1: PRESS & HOLD** the **PROGRAMMING BUTTON** on **CONTROL 1** until the blind jogs.

**STEP 2: BRIEFLY PRESS** the **PROGRAMMING BUTTON** on **CONTROL 2**. The blind jogs.



*Step 1 should not be performed with control intended for deletion.*

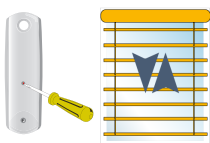

#### CONTROL 1

Previously programmed control - single channel or the channel (1-5) of a multi-channel control.

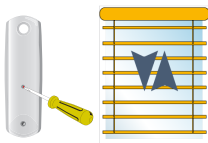

#### CONTROL 2

Second control to be added or deleted - single channel or the channel (1-5) of a multi-channel control.

## RESETTING MOTOR TO FACTORY MODE

(Erasing all Previously Programmed Limit Settings and Channels)

**To delete all previous settings:**  
**PRESS & HOLD** the **PROGRAMMING BUTTON**, located on the top of the motor casing, until the blind jogs 3 times (approx. 12 seconds).

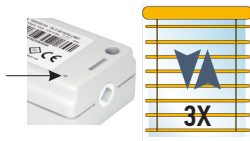

All transmitters and limits will be erased from the motor memory. Motor is now reset to factory mode.

**Motor limits (slat positions) will need to be re-established.**

# QUICK PROGRAMMING FOR TILT 50 WIREFREE™ RTS MOTORS

## SETTING AN INTERMEDIATE "MY" POSITION

1. Press the **UP** or **DOWN** button on a previously programmed transmitter until the blind slats reach a desired intermediate position, then press the **MY/STOP** button to stop. If necessary, adjust with the **UP** or **DOWN** buttons.

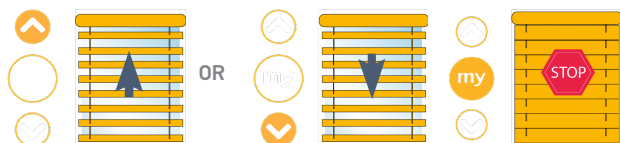

2. **PRESS & HOLD** the **MY/STOP** button on the transmitter until the blind jogs. Intermediate "my" slat position is now added to the memory.



## ACTIVATING THE PREFERRED "MY" POSITION

### Telis, Modulis & DecoFlex Switch

Press momentarily on the **MY/STOP** button. The slats will start moving and stop at the pre-programmed "my" preferred slat position.

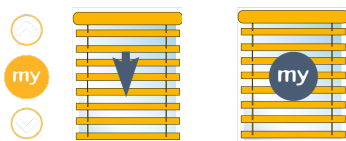

**NOTE: Blind should be stationary prior to activating intermediate position function. If slats are actively moving (in-motion), the MY/STOP button should be pressed twice. First to stop it and then to sent the blind to the programmed "my" position.**

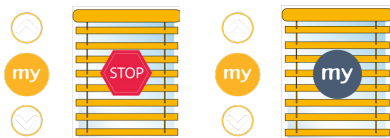



# QUICK PROGRAMMING FOR TILT 50 WIREFREE™ RTS MOTORS

## DELETING AN INTERMEDIATE "MY" POSITION

Activate blind to "my" position, then **PRESS & HOLD** the **MY/STOP** button for 5 seconds until the blind jogs. Previous 'my' position is now deleted.



To set the new "my" position move the blind to the new preferred position then **PRESS & HOLD** the **MY/STOP** button until a jog.

## ADJUSTING LIMITS IN USER MODE

### ADJUSTING THE UPPER LIMIT

1. **BRIEFLY PRESS** the **UP** button to move the blind tilt to the pre-set Upper Limit.

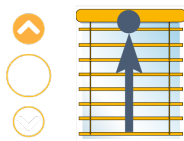

2. Once the blind stops at the pre-set Upper Limit, **PRESS & HOLD** the **UP and DOWN** buttons simultaneously until the blind jogs.



3. Adjust to the new position by using the **UP** or **DOWN** buttons.

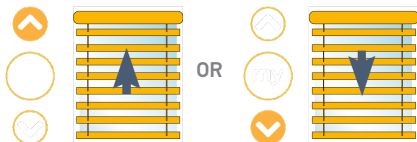

4. **PRESS & HOLD** the **MY/STOP** button until the blind jogs, confirming the new Upper Limit.



# QUICK PROGRAMMING FOR TILT 50 WIREFREE™ RTS MOTORS

## ADJUSTING THE LOWER LIMIT

1. **BRIEFLY PRESS** the **DOWN** button to tilt the blind to the pre-set Lower Limit.



2. Once the blind stops at the pre-set down limit, **PRESS & HOLD** the **UP and DOWN** buttons simultaneously until the blind jogs.



3. Adjust to the new position using **UP** or **DOWN** buttons.

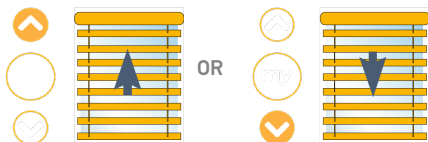

4. **PRESS & HOLD** the **MY/STOP** button until the blind jogs confirming the new Lower Limit.



## USER MODE: Operating the Blind (tilting the slats)

### Telis & DecoFlex Switch Only

Press and hold the **UP** or **DOWN** button to open or close the blind slats. Release the button when the desired position is reached.

**Blind slats will operate at ½ speed.**

Press briefly the **UP** or **DOWN** button and blind slats will move to the programmed limit (**slat position**) at full speed.



## QUICK PROGRAMMING FOR TILT 50 WIREFREE™ RTS MOTORS

### TELIS MODULIS ONLY - Using the Scroll Wheel (tilting the slats)

Scroll the wheel of the Modulis transmitter to move the blind slats up or down. The slats will move in relation to the motion of the wheel on the transmitter.



**BRIEF PRESS** of the **UP** or **DOWN** buttons opens or closes the blind slats to the respective limits (slat positions).

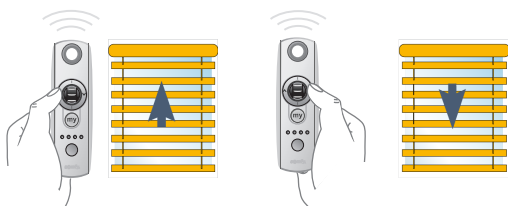

Press the **MY/STOP** button to stop the movement of the slats.

## QUICK PROGRAMMING FOR LT RTS CMO MOTORS

LT50/ LT60 RTS CMO - HARDWIRED OR PLUG-IN



50 mm and 60 mm motor diameter

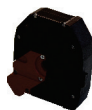

Side view

120V AC



AWNING



ROLLING SHUTTER



EXTERIOR SOLAR SCREENS

### FACTORY MODE

This mode allows for rotation direction modification and setting of the end limits.

**NOTE:** Limits for this motor are set with the mechanical CMO limit switch integrated in the motor and an RTS control. Limits cannot be set or changed from the RTS control alone.

### BEFORE YOU BEGIN

**!** For initial programming, provide power only to the motor being programmed. If the motor is 120V AC hardwired and cannot be disconnected, please contact an electrician prior to calling Somfy customer service for assistance.

For awning installations, an awning hood is strongly recommended.

A drip loop should be formed for all installations (shown below) to prevent water from entering the head of the motor.

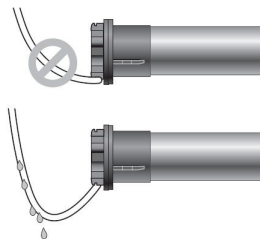
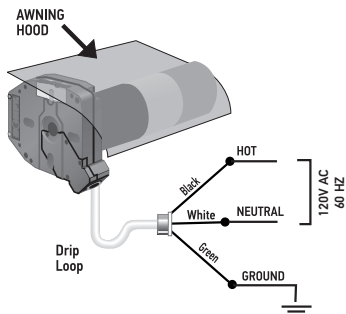

## QUICK PROGRAMMING FOR LT RTS CMO MOTORS

### STEP 1: CONNECT POWER TO MOTOR

 **Remember to power only one motor at a time.**

1) Provide power to the motor to be programmed. Notice the motor will not respond to any transmitter until a transmitter is assigned to communicate with the motor receiver.

2) Remove the protective cap exposing the limit setting buttons on the motor head (replace when finished).

Make sure both limit setting buttons are depressed into the RTS CMO motor.

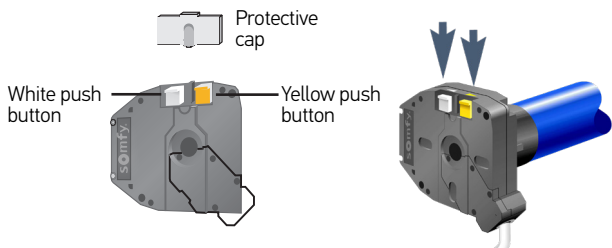

### PROGRAMMING MODE

#### STEP 2: INITIATE PROGRAMMING

**PRESS & HOLD** the **UP** and **DOWN** buttons on the transmitter simultaneously until the motor jogs.



The LT RTS CMO motor will now operate in a momentary fashion.

 **In case of problems with setting of limits during PROGRAMMING MODE, turn the power off to the motor for 2 seconds and then back on to reset the motor.**

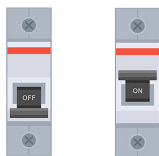

Power OFF for 2 sec.      Power back ON

**Please return to PROGRAMMING MODE to initiate programming process.**

## QUICK PROGRAMMING FOR LT RTS CMO MOTORS

### STEP 3: CHECK THE DIRECTION OF OPERATION

**!** *Installer must verify the correct direction. If the direction is not properly programmed, RTS sensors will not function in the manner intended. Damage to the awning, shutter or screen and injury may occur as a result.*

**PRESS & HOLD** the **DOWN** button and confirm the shutter or awning moves down. If the direction is correct, continue to Step 4.

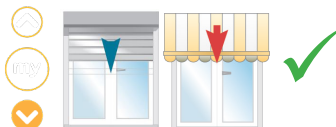

If the direction is incorrect (in reverse) and the application goes up when pressing DOWN, **PRESS & HOLD** the **MY/STOP** button on the transmitter for about 2 seconds until the motor jogs.



### STEP 4: SETTING THE LIMITS

**!** *For larger units, set limit at 1/2 down or out position initially. Finalize programming and allow motor to rest for 10 minutes.*

Identify the Upper and Lower Limit switches on the motor head. Depends on the type of installation - shutter or awning and orientation left or right.

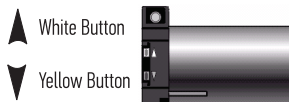

#### Setting the UPPER Limit

**PRESS & HOLD** the **UP** button on the transmitter until a desired upper limit is reached. **PRESS & RELEASE** the Upper Limit button on the motor.

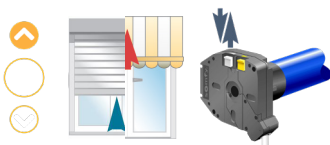

#### Setting the LOWER Limit

**PRESS & HOLD** the **DOWN** button on the transmitter until a desired lower limit is reached. **PRESS & RELEASE** the Lower Limit button on the motor.

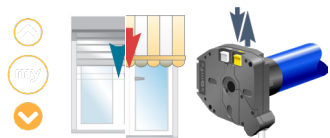

### STEP 5: CONFIRM THE SETTINGS

Once desired limits are set, **PRESS & HOLD** the **PROGRAMMING BUTTON** on the back of the transmitter until the motor jogs.

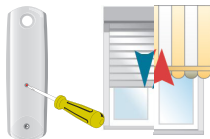

## QUICK PROGRAMMING FOR LT RTS CMO MOTORS

### USER MODE

This mode is for operating the motor by the end user.

Two intermediate "my" positions (IP1 & IP2) can be programmed to the LT RTS CMO motor.

#### INTERMEDIATE POSITION IP1 - referenced from the Upper Limit of the application.

**STEP 1: BRIEFLY PRESS** the **UP** button to send the shutter or awning to the UPPER Limit, then **BRIEFLY PRESS** the **MY/STOP** button once it is reached.

**STEP 2: PRESS & HOLD** both the **MY/STOP** and **DOWN** buttons simultaneously of the RTS transmitter and release them when the shutter or awning begins to move.

**STEP 3:** Stop the shutter or awning at the desired intermediate position.

**STEP 4: PRESS & HOLD** the **MY/STOP** button until the motor jogs indicating that the first intermediate position IP1 is memorized.

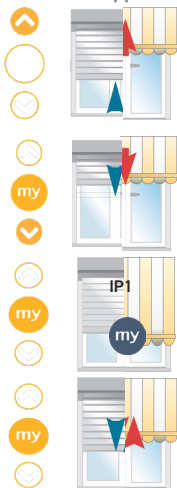

#### INTERMEDIATE POSITION IP2 - referenced from the Lower Limit of the application.

**STEP 1: BRIEFLY PRESS** the **DOWN** button to send the shutter down or awning to the fully extended position, then **BRIEFLY PRESS** the **MY/STOP** button once it is reached.

**STEP 2: PRESS & HOLD** both the **MY/STOP** and **UP** buttons simultaneously of the RTS transmitter and release when the shutter or awning begins to move.

**STEP 3:** Stop the shutter or awning at the desired intermediate position.

**STEP 4: PRESS & HOLD** the **MY/STOP** button until the motor jogs indicating that the the second intermediate position IP2 is memorized.

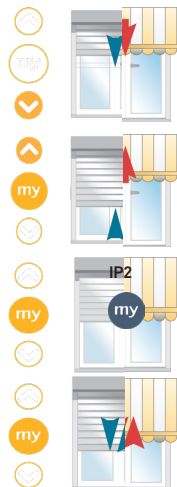

## QUICK PROGRAMMING FOR LT RTS CMO MOTORS

### ADDING OR DELETING CHANNELS OR CONTROLS

The procedure for adding or deleting an RTS control is the same.

**STEP 1: PRESS & HOLD** the **PROGRAMMING BUTTON** on **CONTROL 1** until the motor jogs.

**STEP 2: BRIEFLY PRESS** the **PROGRAMMING BUTTON** on **CONTROL 2**. The motor jogs.

 ***Step 1 should not be performed with control intended for deletion.***



#### CONTROL 1

Previously programmed control - single channel or the channel (1-5) of a multi-channel control.



#### CONTROL 2

Second control to be added or deleted - single channel or the channel (1-5) of a multi-channel control.

### RESETTING MOTOR TO FACTORY MODE

All controls will be erased from motor's memory. The motor limits are not affected by this procedure. If the limits need to be adjusted refer to the limit setting instructions.

**NOTE:** *The motor cannot be reset if it is already in factory mode.*

**STEP 1:** Perform a dual power cut in the following sequence:



1. Power OFF for 2 seconds



2. Power ON for 10 seconds



3. Power OFF for 2 seconds



4. Power back ON

The shutter or awning moves for about 5 seconds in one direction, indicating that the dual power cut has been recorded. The motor is in **programming mode** for 2 minutes.



**STEP 2: PRESS & HOLD** the **PROGRAMMING BUTTON** of the previously programmed transmitter/channel. The motor jogs indicating that the motor's memory has been cleared of all RTS controls and sensors.

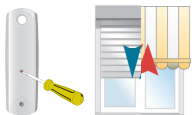

If the original transmitter is missing use any RTS transmitter - it will now be programmed to the motor, all previous controls will be deleted.



# QUICK PROGRAMMING FOR MAESTRIA™ 50 RTS MOTORS



MAESTRIA™ - HARDWIRED OR PLUG-IN



50 mm motor diameter

120V AC

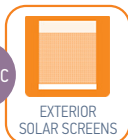

EXTERIOR SOLAR SCREENS



Side view

**STOP** **BEFORE YOU BEGIN:** Motors are shipped in **factory mode** without limit settings or the transmitter ID's.

**!** **NOTE:** If the motor is 120V AC hardwired and cannot be disconnected, please contact an electrician prior to calling Somfy customer service for assistance.

## STEP 1: CONNECT THE MOTOR TO POWER

With the motor installed in the screen, connect power to the motor being programmed (120V AC). Remember to power only **ONE MOTOR AT A TIME**. All other screens must be disconnected from their respective power while programming.

**!** While programming, screens should not be inactive for longer than 2 minutes or the motor will exit programming mode.

## STEP 2: INITIATE PROGRAMMING

On the transmitter, **BRIEFLY PRESS** both **UP** and **DOWN** buttons simultaneously: the screen jogs. The motor is now in **programming mode**.



## STEP 3: CHECK THE DIRECTION OF OPERATION

**STOP** If the transmitter direction is not properly programmed, RTS sensors will not function in the manner intended. Damage to the screens and injury may occur as a result.

Check the direction of rotation by pressing **UP** or **DOWN**. When pressing **DOWN** the screen should go down.



If necessary, change the direction of rotation. To do that **PRESS & HOLD** the **MY/STOP** button until the screen jogs. Verify direction before proceeding.



# QUICK PROGRAMMING FOR MAESTRIA™ 50 RTS MOTORS

## STEP 4: SET THE LIMITS (Select the programming option according to the type of screen - with or without a hard stop)

### MANUAL LIMIT SETTING For all types of screens

1) Position the screen at the desired UPPER Limit, then press **MY/STOP** and **DOWN** simultaneously: the screen lowers. Stop the screen near the desired LOWER Limit. Adjust using UP or DOWN.

2) Once the screen is at the desired LOWER Limit, then press **MY/STOP** and **UP** simultaneously: the screen raises.

4) **PRESS & HOLD** the **MY/STOP** until the screen jogs validating the end limit setting.

5) To COMPLETE & EXIT PROGRAMMING **BRIEFLY PRESS** the **PROGRAMMING BUTTON** on the control: the screen jogs. The control is programmed, limits are set and the screen is now in **user mode**.

### AUTOMATIC LIMIT SETTING\*

#### Only for screens featuring a hard stop

1) Bring the screen to its half-way position, then **BRIEFLY PRESS** the **UP and DOWN** simultaneously: the screen jogs.

2) Press the **DOWN** button: the screen lowers until it detects the Lower Limit, performs a brief upward movement and returns to its Lower Limit position.

3) To validate the setting, press **MY/STOP** until the screen jogs.

 *If the lower end limit is not set automatically after several attempts, restart the setting and perform the steps on the following page.*

To EXIT PROGRAMMING **BRIEFLY PRESS** the **PROGRAMMING BUTTON** on the control: the screen jogs. The control is programmed, limits are set and the screen is now in **user mode**.



# QUICK PROGRAMMING FOR MAESTRIA™ 50 RTS MOTORS

## SEMI-AUTOMATIC LIMIT SETTING\*

(The LOWER limit is set manually and the UPPER limit is set automatically)

### Only for screens featuring a hard stop

- 1) Position the screen at the desired LOWER Limit, then press **MY/STOP** and **UP** buttons simultaneously: the screen raises.
- 2) Press **MY/STOP** to stop the screen and press **MY/STOP** button again until the screen jogs to validate the LOWER Limit setting.



To EXIT PROGRAMMING **BRIEFLY PRESS** the **PROGRAMMING BUTTON** on the control: the screen jogs. The control is programmed, limits are set and the screen is now in **user mode**.

\* The UPPER Limit in **AUTOMATIC** and **SEMI-AUTOMATIC MODE** is automatically calculated during the first 4 cycles in user mode. No additional steps are required. After those 4 cycles, Maestria will stop at the UPPER limit. The motor will automatically recalculate the UPPER limit on a regular basis, compensating any fabric expansion and ensuring fabric tightness.

## SEMI-AUTOMATIC LIMIT SETTING FOR SCREENS WITH AUTOMATIC CATCHING SYSTEM (LOCK SYSTEM)

(The LOWER limit is set manually and the UPPER limit is set automatically)

 The catching system at the lower end limit may vary depending on the screen, but the procedure for setting limit positions of the catches remains the same on all systems.

- 1) Starting from the half-way position **PRESS & HOLD** both **UP** and **DOWN** buttons simultaneously for 5 seconds until a slow up and down movement.



- 2) Press the **DOWN** button: the screen lowers.

- 3) Press the **MY/STOP** button to stop the screen at position (P1), which corresponds to the automatic catching system's entrance point.

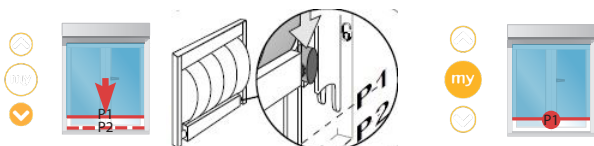

## QUICK PROGRAMMING FOR MAESTRIA™ 50 RTS MOTORS

4) Press **MY/STOP** and **UP** simultaneously: the screen raises and then stops, putting tension on the fabric.

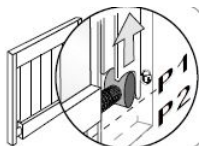

5) Press the **DOWN** button: the screen lowers.

Then press the **MY/STOP** button to stop the screen at position (P2), which corresponds to the automatic catching system's exit point.



7) Press **MY/STOP** until the screen jogs validating the end limit settings.



To EXIT PROGRAMMING **BRIEFLY PRESS** the **PROGRAMMING BUTTON** on the control: the screen jogs. The control is programmed, limits are set and the screen is now in **user mode**.



### MANUAL ADJUSTMENT OF END LIMITS FOR SCREENS WITH AUTOMATIC CATCHING SYSTEM (LOCK SYSTEM)

**!** *The catching system at the lower end limit may vary depending on the screen, but the procedure for setting limit positions of the catches remains the same on all systems.*

1) Starting from the half-way position **PRESS & HOLD** the **UP** and **DOWN** buttons simultaneously for 5 seconds until the motor jogs.



5 sec.



2) Press the **UP** button: the screen raises. Next press the **MY/STOP** button to stop the screen at the UPPER Limit. Adjust if necessary.



3) Press the **MY/STOP** and **DOWN** buttons simultaneously: the screen lowers.



6) Press the **MY/STOP** button to stop the screen at position (P1), which corresponds to the automatic catching system's entrance point.



## QUICK PROGRAMMING FOR MAESTRIA™ 50 RTS MOTORS

- 7) Press **MY/STOP** and **UP** buttons simultaneously: the screen raises and stops, putting tension on the fabric.



- 8) Press the **DOWN** button: the screen lowers.

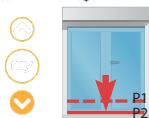

- 9) Press the **MY/STOP** button to stop the screen at position (P2), which corresponds to the automatic catching system's exit point.



- 10) Press the **MY/STOP** button until the screen jogs to validate the end limit setting.

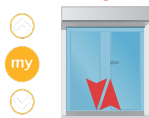

To COMPLETE & EXIT PROGRAMMING **BRIEFLY PRESS** the **PROGRAMMING BUTTON** on the control: the screen jogs. The control is programmed, limits are set and the screen is now in **user mode**.



## USER MODE

### PROGRAMMING OF A NEW CONTROL (NON-PRE-PROGRAMMED)

- 1) Switch off the power supply (the pre-programmed transmitter is deleted). Switch the main power supply back on. The screen jogs.



Cut power for 2 sec.



Power back ON



- 3) Simultaneously **PRESS & HOLD** the **UP** and **DOWN** buttons of the new control to be programmed, until the screen jogs.



- 4) **BRIEFLY PRESS** the **PROGRAMMING BUTTON** of this control: the screen jogs. The control is programmed to the motor.

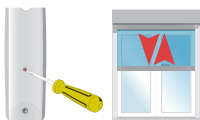

# QUICK PROGRAMMING FOR MAESTRIA™ 50 RTS MOTORS

## OBSTACLE DETECTION



This function gives the possibility to deactivate the obstacle detection or increase the sensitivity up from the default level during the downward movement.

When adjusting obstacle detection, all button presses must be completed within 2 seconds of the previous press or the motor will exit the setting mode. If that happens start from the beginning.

### 1. ENTER THE OBSTACLE SETTING MODE

Move the screen to the half-way position, **BRIEFLY PRESS** the **MY** and **UP** buttons then **PRESS & HOLD** the **MY** and **UP** buttons until the screen jogs.

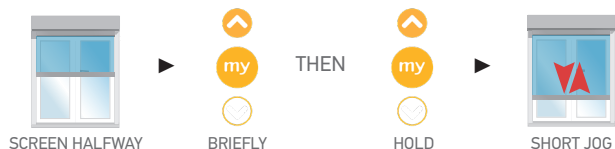

### 2. CHANGE THE OBSTACLE DETECTION LEVEL

If the actuator goes back to **user mode** (short jog) repeat Step 1.

#### To Deactivate:

Within 2 seconds **BRIEFLY PRESS** the **UP** button and then press **UP** briefly again. The screen will jog slowly and is now deactivated.



**IF THE JOG IS SHORT YOU'VE REACHED THE DEFAULT SETTING. TO DEACTIVATE PRESS UP AGAIN.**

#### To Increase Sensitivity:

Within 2 seconds **BRIEFLY PRESS** the **DOWN** button, then press **DOWN** briefly again. The screen will jog slowly and is now more sensitive.



**IF THE JOG IS SHORT YOU'VE REACHED THE DEFAULT SETTING. TO INCREASE SENSITIVITY PRESS DOWN AGAIN**

### 3. CONFIRM THE NEW SETTING & EXIT THE SETTING MODE

**PRESS & HOLD** the **MY/STOP** button until the screen jogs confirming the new setting.



The obstacle detection will be at this level, when entering the settings again from Step 1 at the top of the page.

# QUICK PROGRAMMING FOR MAESTRIA™ 50 RTS MOTORS

## ADDING/DELETING A TRANSMITTER

### 1. INITIATE PROGRAMMING

**PRESS & HOLD** the **PROGRAMMING BUTTON** (about 3 seconds) of an already programmed remote control. The motor will jog and is now in programming mode.



3 sec.



SHORT JOG

### 2A. ADDING A NEW TRANSMITTER

**BRIEFLY PRESS** the **PROGRAMMING BUTTON** on the back of the transmitter to be added.

The motor jogs.



0.5 sec.



SHORT JOG

New transmitter is programmed and ready to operate the screen.

### 2B. DELETING A TRANSMITTER

**BRIEFLY PRESS** the **PROGRAMMING BUTTON** on the back of the previously programmed transmitter to be deleted. The motor jogs.



0.5 sec.



SHORT JOG

The transmitter is now deleted from the motor's memory.

# QUICK PROGRAMMING FOR MAESTRIA™ 50 RTS MOTORS

## ADJUSTING THE LIMITS IN USER MODE

### TO CHANGE THE LOWER LIMIT

**STEP 1:** Press the **DOWN** button to send the screen to its current Lower Limit.



**STEP 2: PRESS & HOLD** both **UP and DOWN** buttons simultaneously until the screen jogs.



**STEP 3:** Adjust to a new Lower limit position.



**STEP 4: PRESS & HOLD** the **MY/STOP** button until the screen jogs, to confirm the new limit.



### TO CHANGE THE UPPER LIMIT:

**STEP 1:** Press the **UP** button to send the screen to its current Upper Limit.



**STEP 2: PRESS & HOLD** both **UP and DOWN** buttons simultaneously until the screen jogs.



**STEP 3:** Adjust to a new Upper limit position.

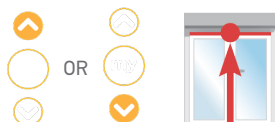

**STEP 3: PRESS & HOLD** the **MY/STOP** button until the screen jogs, to confirm the new limit.





# QUICK PROGRAMMING FOR MAESTRIA™ 50 RTS MOTORS

## RESETTING MOTOR TO FACTORY MODE

### 1.PERFORM DOUBLE POWER CUT-OFF



Power ON



Cut power for 2 sec.



Power back ON for 10 seconds



Cut power for 2 sec.



Power ON



SHORT JOG

### 2.FINISH THE RESET



7 seconds



SHORT JOG



SHORT JOG

**PRESS & HOLD** the **PROGRAMMING BUTTON** on the back of the control for about 7 seconds.

The motor will jog after 2 seconds. Keep holding.

And then the motor will jog again validating the reset.

# QUICK PROGRAMMING FOR SUNEА® RTS CMO MOTORS

SUNEА® - HARDWIRED OR PLUG-IN

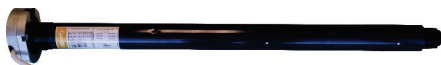

50 mm motor diameter



Side view

120V AC



AWNING



EXTERIOR SOLAR SCREENS

The Sunea® RTS CMO is a universal motor for retractable standard and cassette awnings and features:

1. **Back release** function at top of end limit.
2. Possibility to choose the **closing force**.



## BEFORE YOU BEGIN:



*For awning installations, an awning hood is strongly recommended. Drip loop should be formed to prevent water from entering the head of the motor.*

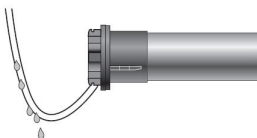

## STEP 1: CONNECT POWER TO THE MOTOR

Connect 120V AC to the Sunea® motor via the proper extension cable with NEMA plug.

*Remember to power only the motor being programmed.*



## PROGRAMMING MODE

### STEP 2: INITIATE PROGRAMMING

**BRIEFLY PRESS** the **UP** and **DOWN** buttons on the transmitter simultaneously until the motor jogs.



The motor is now in **PROGRAMMING MODE**, the awning will move only when the UP or DOWN is held (in momentary fashion).

# QUICK PROGRAMMING FOR SUNEА® RTS CMO MOTORS

## STEP 3: CHECK THE DIRECTION OF OPERATION

 **Installer must verify the direction of operation.** If the direction is incorrect, RTS sensors **will not function** in the manner intended. Damage to motorized window covering and injury may occur as a result.

**PRESS & HOLD** the **DOWN** button and confirm the shutter or awning moves down. If the direction is correct, continue to Step 4.



If the direction is incorrect (in reverse) and the application goes up when pressing **DOWN**, **PRESS & HOLD** the **MY/STOP** button on the transmitter for about 2 seconds until the motor jogs.



## STEP 3: SETTING LIMITS FOR STANDARD RETRACTABLE AWNING

(Both **UP** and **DOWN** Limits need to be set)



**STEP 1:** Bring the awning to your desired upper limit. **PRESS & HOLD** both the **MY/STOP** and **DOWN** buttons simultaneously until the awning begins to extend, then release.



**STEP 2:** Stop the motor where the Lower Limit should be set. Adjust by pressing the **UP** or **DOWN** buttons.



**STEP 3:** **PRESS & HOLD** both the **MY/STOP** and **UP** buttons simultaneously until the awning begins to retract. The motor will stop at the upper limit set in Step 1.



**STEP 4:** **PRESS & HOLD** the **MY/STOP** button until the awning performs a long jog (a hard upper limit stop will take place) then release.



**STEP 5:** **PRESS & HOLD** the **PROGRAMMING BUTTON** on the back of the transmitter until the awning jogs. It will now operate in a maintained fashion. Double check limits as a precaution.

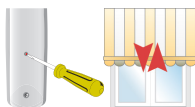

# QUICK PROGRAMMING FOR SUNEA® RTS CMO MOTORS

## SETTING LIMITS FOR CASSETTE AWNINGS

(Only LOWER Limit needs to be set. The upper limit is set automatically.)



**!** Limit setting must start from the DOWN or extended position. Do not start limit setting from the UP position as it is automatically set.

*In case of problems with setting of limits during PROGRAMMING MODE, turn the power off to the motor for 2 seconds and then back on to reset the motor. Please return to PROGRAMMING MODE to initiate programming process.*

**STEP 1:** Bring the awning to your desired lower limit. **PRESS & HOLD** both the **MY/STOP** and **UP** buttons simultaneously until the awning begins to move up, then release.



**STEP 2:** Press the **MY/STOP** button and stop the awning halfway UP, before the UP limit is reached.



**STEP 3:** **PRESS & HOLD** the **MY/STOP** button again until the awning moves to set its UPPER limit automatically.



**STEP 4:** **PRESS & HOLD** the **PROGRAMMING BUTTON** on the back of the transmitter until the awning jogs. The motor is now in **user mode** and will now operate in a maintained fashion. Double check limits as a precaution.



## ADJUSTING LIMIT IN USER MODE

### Adjusting the lower limit

Send the motor to its current LOWER limit position with the transmitter and let it stop.



**PRESS & HOLD** both the **UP** and **DOWN** buttons simultaneously until the awning jogs, then release. Adjust to a new LOWER limit position.

**PRESS & HOLD** the **MY/STOP** button until the awning jogs, then release. Check new limit.

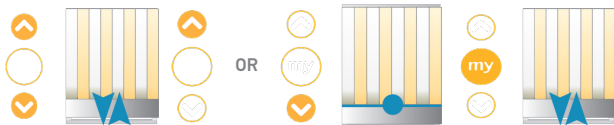

# QUICK PROGRAMMING FOR SUNEА® RTS CMO MOTORS

## Adjusting the upper limit

(Only For Standard Retractable Awnings)

Send the motor to its current upper limit position and let it stop.



**PRESS & HOLD** both the **UP** and **DOWN** buttons simultaneously until the awning jogs, then release. Adjust to a new Upper Limit position. Press the **MY/STOP** button until the awning jogs, then release. Check new limit.



## ADDING OR DELETING A TRANSMITTER

(Single Channel, Multi Channel, or Sensor)

First, **PRESS & HOLD** the **PROGRAMMING BUTTON** on the back of the already programmed remote until the awning jogs.



Then **BRIEFLY PRESS** the **PROGRAMMING BUTTON** on the remote or sun/wind sensor that you would like to add until the awning jogs. Check it.



## RESETTING MOTOR TO FACTORY MODE

**STEP 1: Perform double power cut-off**

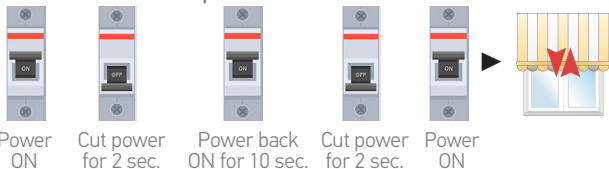

**STEP 2: Finish the reset**

**PRESS & HOLD** the **PROGRAMMING BUTTON** on the back of the control for about 7 sec.

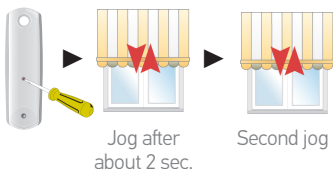

All transmitters and limits will be erased, the motor is now in **factory mode**. Motor limits will need to be re-established.

# QUICK PROGRAMMING FOR SUNEА® RTS CMO MOTORS

## ADJUSTING FABRIC TENSION (Advanced Features Function)

 *The **back impulse** function for both Standard and Cassette Retractable Awnings. Allows to apply tension on the fabric when the awning is fully extended. The motor can be adjusted up to a ½ half turn.*

**STEP 1:** Send the awning to the lower limit (fully extended).

**To Activate this Function:**

**STEP 2: PRESS & HOLD** both the **MY/STOP** and **UP** buttons simultaneously until the awning jogs. The motor is in **PROGRAMMING MODE**.

**STEP 3:** Adjust the fabric's tension using the **UP** or **DOWN** buttons.

**STEP 4: PRESS & HOLD** the **MY/STOP** button until the awning jogs. The fabric's tension has been programmed.

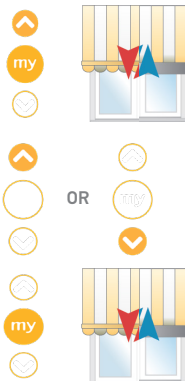

## BACK RELEASE FUNCTION FOR CASSETTE AWNINGS ONLY

 *This function allows the fabric tension to be released after the cassette awning is closed.*



Send the awning to the upper limit (CLOSED position) with the transmitter.

**To Activate this Function:**

**STEP 1:** Cut the power for 2 sec, then plug back in unless you are using the awning in the first 4 cycles.



Cut power for 2 sec.



Power back ON

**PRESS & HOLD** both the **MY/STOP** and **DOWN** buttons simultaneously until the awning jogs.



If the **back release** function was deactivated, it is now activated.

If the **back release** function was active, it is deactivated.

# QUICK PROGRAMMING FOR SUNEА® RTS CMO MOTORS

## CLOSING FORCE ADJUSTMENT - FOR CASSETTE AWNINGS ONLY



 *This function enables the closing force of the cassette awning to be increased or decreased to 3 levels (high/medium/low). The motor is factory set at the medium level.*

**STEP 1:** Bring the awning to the half-way position.

### To Activate this Function:

**STEP 2:** Cut the power for 2 seconds then plug back in, unless you are using the awning in the first 4 cycles.



Cut power for 2 sec.



Power back ON

**STEP 3:** BRIEFLY PRESS the **MY/STOP** and **UP** buttons simultaneously, then immediately press and hold the **MY/STOP** and **UP** buttons again until the motor jogs.



The motor is only in **programming mode** for approx. 10 seconds.

**STEP 4:** Adjust the closing force setting using the UP and DOWN buttons.

**To increase the closing force,** press the **UP** button until the motor jogs.



**To decrease the closing force,** press the **DOWN** button until the motor jogs (long jog for levels 3 and 1) (short jog for level 2).



**STEP 5:** PRESS & HOLD the **MY/STOP** button until the awning jogs.

The new **closing force** has been programmed.



# QUICK PROGRAMMING FOR OXIMO™ RTS MOTORS

OXIMO™ - HARDWIRED OR PLUG-IN



50 mm motor diameter



Side view

120V AC



ROLLING SHUTTER



**BEFORE YOU BEGIN:** Motors are shipped in **factory mode** without limit settings or the transmitter ID's.



**NOTE:** *If the motor is 120V AC hardwired and cannot be disconnected, please contact an electrician prior to calling Somfy customer service for assistance.*

## STEP 1: CONNECT THE MOTOR TO POWER

With the motor installed in the shutter, connect power to the motor being programmed (120V AC). Remember to power only ONE MOTOR AT A TIME. All others must be disconnected from power while programming.

## STEP 2: INITIATE PROGRAMMING

To wake the motor **PRESS & HOLD** the **UP** and **DOWN** buttons simultaneously until the motor jogs.



## STEP 3: CHECK THE DIRECTION OF ROTATION

When pressing the **DOWN** button the shutter should go down.



If the direction is incorrect (in reverse) and the application goes up when pressing DOWN, **PRESS & HOLD** the **MY/STOP** button on the transmitter for about 2 seconds until the motor jogs.



Verify correct direction before proceeding.

## STEP 4: SET THE LIMITS

Select the programming option according to the type of application (rigid links, bottom stop, standard links, no bottom stop).



# QUICK PROGRAMMING FOR OXIMO™ RTS MOTORS

## AUTOMATIC LIMIT SETTING -

For shutters with rigid links and bottom stops only.

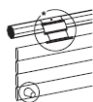

1) **PRESS & HOLD** the **UP** and **DOWN** buttons simultaneously until the motor jogs.



2) **PRESS & HOLD** the **MY/STOP** button until the motor jogs to confirm the limit setting.



3) **PRESS & HOLD** the **PROGRAMMING** **BUTTON** on the back of the transmitter until the motor jogs.



*The buttons no longer have to be held for the motor to run.  
The motor will auto detect both limits from the physical stops.*

## UPPER LIMIT SET MANUALLY, AUTOMATIC LOWER LIMIT - For shutters with rigid links and no bottom stops only.



1) Run the motor to the desired upper limit. Then **PRESS & HOLD** the **MY/STOP** and **DOWN** buttons simultaneously until the motor starts to run downward. Use the **MY/STOP** button to stop the motor.

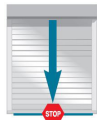

2) **PRESS & HOLD** the **MY/STOP** button until the motor jogs to confirm the limit setting.



3) **PRESS & HOLD** the **PROGRAMMING** **BUTTON** on the back of the transmitter until the motor jogs.



*The buttons no longer have to be held for the motor to run.  
The motor will auto detect the lower limit from the physical stop.*

# QUICK PROGRAMMING FOR OXIMO™ RTS MOTORS

LOWER LIMIT SET MANUALLY, UPPER LIMIT SET AUTOMATICALLY - For shutters with standard links at top and bottom stop only.



1) Run the motor to the desired lower limit.



2) **PRESS & HOLD** the **MY/STOP** and **UP** buttons simultaneously until the motor starts to run upward.



3) Use the **MY/STOP** button to stop the motor.



4) **PRESS & HOLD** the **MY/STOP** button until the motor jogs to confirm the limit setting.



5) **PRESS & HOLD** the **PROGRAMMING BUTTON** on the back of the transmitter until the motor jogs.

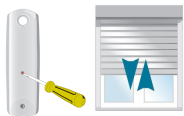

*The buttons no longer have to be held for the motor to run. The motor will auto detect the upper limit from the physical stop.*

# QUICK PROGRAMMING FOR OXIMO™ RTS MOTORS

## BOTH LIMITS SET MANUALLY -

For shutters with standard links at top and no bottom stop.



1) Run the motor to the desired upper limit.



2) **PRESS & HOLD** the **MY/STOP** and **DOWN** buttons simultaneously until the motor starts to run downward.



3) Use the **MY/STOP** button to stop the motor near the desired lower limit. Use the **UP** or **DOWN** button to position the shutter at the exact desired lower limit.



4) **PRESS & HOLD** the **MY/STOP** and **UP** buttons simultaneously until the motor starts to run.



5) Use the **MY/STOP** button to stop the motor



6) **PRESS & HOLD** the **MY/STOP** button until the motor jogs to confirm the limit settings.



**Note:** Until this step, the limits can be adjusted by repeating the steps from the top of the page.

7) **PRESS & HOLD** the **PROGRAMMING BUTTON** on the back of the transmitter until the motor jogs.



*The buttons no longer have to be held for the motor to run.  
Double check the limits are in the desired position.*

# QUICK PROGRAMMING FOR OXIMO™ RTS MOTORS

## USER MODE

### ADJUSTING THE LIMITS IN USER MODE

**NOTE:** *Only limits set manually can be adjusted. All automatic limits are set by the motor detecting a physical block and are reconfirmed by the motor every 56 cycles or after a power cut.*

#### Adjusting the upper limit

Run the motor to its current upper limit and let it stop.



**PRESS & HOLD** the **UP** and **DOWN** buttons simultaneously until the motor jogs.



Run the motor to the new desired upper limit.



**PRESS & HOLD** the **MY/STOP** button until the motor jogs. Check the new limit.



#### Adjusting the lower limit

Run the motor to its current lower limit and let it stop.



**PRESS & HOLD** the **UP** and **DOWN** buttons simultaneously until the motor jogs.



Run the motor to the new desired lower limit.



**PRESS & HOLD** the **MY/STOP** button until the motor jogs. Check the new limit.



# QUICK PROGRAMMING FOR OXIMO™ RTS MOTORS

## ADDING OR DELETING CHANNELS OR CONTROLS

The procedure for adding or deleting an RTS control is the same.

**STEP 1: PRESS & HOLD** the **PROGRAMMING BUTTON** on **CONTROL 1** until the motor jogs.

**STEP 2: BRIEFLY PRESS** the **PROGRAMMING BUTTON** on **CONTROL 2**. The motor jogs.

 **Step 1 should not be performed with control intended for deletion.**



### CONTROL 1

Previously programmed control - single channel or the channel (1-5) of a multi-channel control.



### CONTROL 2

Second control to be added or deleted - single channel or the channel (1-5) of a multi-channel control.

## RESETTING THE MOTOR TO FACTORY MODE

### 1. Perform a double power cut-off



Power ON



Cut power for 2 sec.



Power back ON for 10 seconds



Cut power for 2 sec.



Power ON



SHORT JOG

The motor should jog or start to run. If this does not happen, repeat the power cuts until the motor does run.

Allow the motor to stop on its own. Do not press stop, up or down or you will have to repeat the double power cut.

### STEP 2: Finish the reset

**PRESS & HOLD** the **PROGRAMMING BUTTON** on the back of the control for about 7 sec.



SHORT JOG



SHORT JOG

All transmitters and limits will be erased. The motor is now in **FACTORY MODE**. Motor limits will need to be re-established.

# QUICK PROGRAMMING FOR DRAPERY RTS MOTORS

GLYDEA® 35E & 60E RTS - PLUG-IN DRAPERY MOTORS

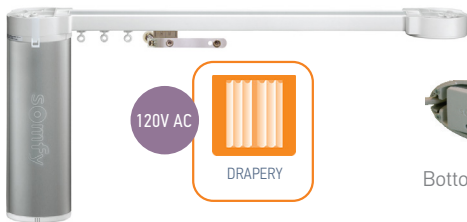

120V AC



DRAPERY



Bottom view

GLYDEA® ULTRA RTS - PLUG-IN DRAPERY MOTORS



120V AC



DRAPERY



Bottom view  
with cover



Bottom view  
without cover

IRISMO™ 35 RTS & 45 WIREFREE RTS DRAPERY MOTORS

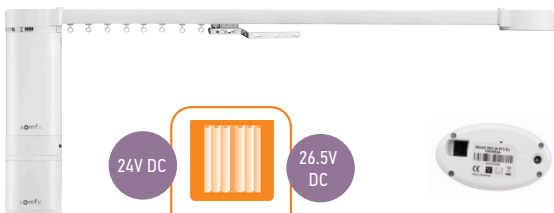

24V DC



DRAPERY

26.5V  
DC



Bottom view

# QUICK PROGRAMMING FOR DRAPERY RTS MOTORS

Glydea® 35e RTS, Glydea® 60e RTS, Glydea® ULTRA RTS,  
Irisimo™ 35 Mini DC, Irisimo™ 45 WireFree RTS

- Motor placement left or right and/or upside down installation
- Touch motion
- Speed adjustment

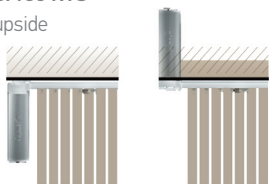

Standard Mounting    Inverse Mounting

## BEFORE YOU BEGIN



Manually move drapery to a middle position along the track. This allows for movement of the motor in either direction.

## STEP 1: CONNECT POWER TO THE MOTOR



Glydea® motors are equipped with an integrated 120V AC NEMA power plug with a 10 ft. cable



Irisimo™ 35 Mini DC is equipped with a plug-in low voltage (24V DC) transformer.



Irisimo™ 45 WireFree RTS is equipped with a rechargeable (26.5V DC) battery, which can be recharged with a power adaptor #1002945.



**NOTE:** When working with multiple motorized draperies power only the one being programmed.

## QUICK PROGRAMMING FOR DRAPERY RTS MOTORS

### STEP 2: INITIATE PROGRAMMING

PRESS & HOLD the **OPEN/UP** and **CLOSE/DOWN** buttons simultaneously until the drapery jogs.



### STEP 3: LIMIT SETTING

BRIEFLY PRESS **OPEN/UP** or **CLOSE/DOWN**, the drapery automatically runs to record both hard stop positions.

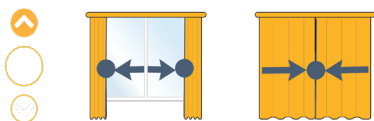

### STEP 3: CHECK THE DIRECTION OF OPERATION

Press **OPEN/UP** button

- If the drapery opens, the direction of rotation is correct, go to STEP 4.

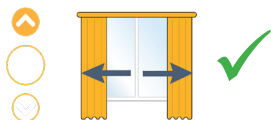

- If the drapery closes, the direction of rotation is incorrect, press the **MY/STOP** button until the drapery jogs: the direction of rotation has been modified.



To confirm press the **OPEN/UP** button and check the direction of rotation again.

### RECORDING THE RTS TRANSMITTER

STEP 5: PRESS & HOLD the **PROGRAMMING BUTTON** on the back of the RTS transmitter until the drapery jogs. The RTS transmitter is now recorded.

To operate the drapery press the **OPEN/UP** or **CLOSE/DOWN** button.

The drapery is now in **user mode**.





## QUICK PROGRAMMING FOR DRAPERY RTS MOTORS

### USER MODE

#### MODIFYING THE DIRECTION OF OPERATION IN USER MODE

First, move the drapery away from the limit. Then **PRESS & HOLD** the **OPEN/UP** and **CLOSE/DOWN** buttons simultaneously until the drapery jogs.



Then **PRESS & HOLD** the **MY/STOP** button until the drapery jogs to reverse the rotation direction.



#### SETTING PREFERRED "MY" POSITION

**STEP 1:** Move the drapery to the desired intermediate position with the **OPEN/UP** or **CLOSE/DOWN** buttons.



**STEP 2:** **PRESS & HOLD** the **MY/STOP** button until the drapery jogs to confirm setting.

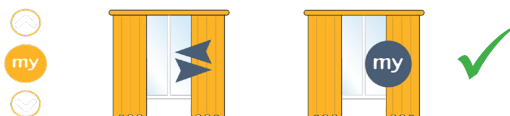

#### DELETING OR ADJUSTING INTERMEDIATE "MY" POSITION

To delete the "my" position, move the drapery to the current "my" position, then **PRESS & HOLD** the **MY/STOP** button until the drapery jogs.

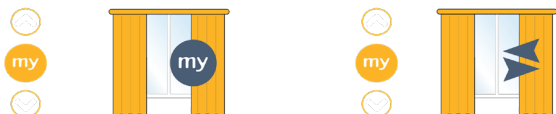

To set new "my" position, follow the steps 1 and 2 above.

## QUICK PROGRAMMING FOR DRAPERY RTS MOTORS

### ADJUSTING THE LIMITS IN USER MODE

**STEP 1:** Press the **OPEN/UP** or **CLOSE/DOWN** button to move the drapery to the limit to be re-adjusted.



**STEP 2: PRESS & HOLD** the **OPEN/UP** and **CLOSE/DOWN** buttons simultaneously until the drapery jogs.



**STEP 3:**  
Move the drapery to the new desired position using **UP** or **DOWN** buttons.

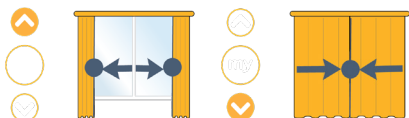

**STEP 4:** To confirm the new limit, **PRESS & HOLD** the **MY/STOP** button until the drapery jogs.



### ADDING OR DELETING CHANNELS OR CONTROLS

The procedure for adding or deleting an RTS control is the same.

**STEP 1: PRESS & HOLD** the **PROGRAMMING BUTTON** on **CONTROL 1** until the drapery jogs.

**STEP 2: BRIEFLY PRESS** the **PROGRAMMING BUTTON** on **CONTROL 2**. The drapery jogs.

 **Step 1 should not be performed with control intended for deletion.**



#### CONTROL 1

Previously programmed control  
- single channel or the channel  
(1-5) of a multi-channel control.

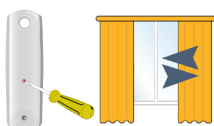

#### CONTROL 2

Second control to be added or deleted  
- single channel or the channel (1-5)  
of a multi-channel control.

## QUICK PROGRAMMING FOR DRAPERY RTS MOTORS

### ACTIVATING THE TOUCH MOTION FEATURE

**NOTE:** By default the touch motion feature is not activated.

**STEP 1:** Press **OPEN/UP** or **CLOSE/DOWN** button to move the drapery away from the limit.



**STEP 2:** To initiate programming, **PRESS & HOLD** the **OPEN/UP** and **CLOSE/DOWN** button simultaneously until the drapery jogs.



**STEP 3:** To activate the:

**Standard Sensitivity Setting**  
(more sensitive)

**PRESS & HOLD** the **OPEN/UP** and **CLOSE/DOWN** buttons simultaneously until the drapery jogs (total of 2 jogs including Step 2).



**Low Sensitivity Setting**  
(less sensitive)

**PRESS & HOLD** both **OPEN/UP** and **CLOSE/DOWN** buttons until the drapery jogs once. Then press the same buttons again until the drapery jogs again (total of 3 jogs including Step 2).



**STEP 4:** **PRESS & HOLD** the **MY/STOP** button until the drapery jogs to confirm the setting.



## QUICK PROGRAMMING FOR DRAPERY RTS MOTORS

### ADJUSTMENT OF SPEED SETTING

**STEP 1: PRESS & HOLD** both **MY/STOP** and **OPEN/UP** buttons simultaneously until the drapery starts to open and close automatically.



**STEP 2:** Press **OPEN/UP** to increase and **CLOSE/DOWN** to decrease speed.



FASTER



SLOWER

**STEP 3: PRESS & HOLD** the **MY/STOP** button until the drapery jogs to confirm the setting.



### SILENT MODE SWITCH

available for Glydea® ULTRA motors

Toggle between SILENT and HI-SPEED (default) modes.

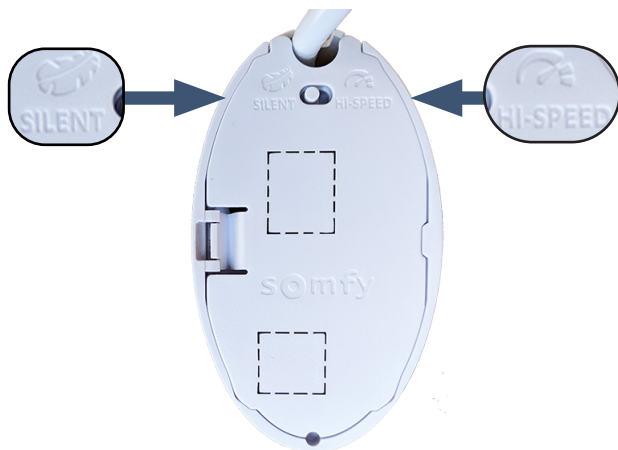

## QUICK PROGRAMMING FOR DRAPERY RTS MOTORS

### DELETING ALL CONTROLS & RETAINING LIMIT SETTINGS

Locate the **PROGRAMMING BUTTON** on the motor then **PRESS & HOLD** it until the drapery jogs 2 times:

**PROGRAMMING  
BUTTON**



Glydea®



"S" BUTTON  
(PROGRAMMING)

Glydea® ULTRA

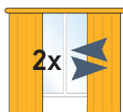

All controls are erased, but limits are retained.

### RESETTING THE MOTOR TO FACTORY MODE

Locate the **PROGRAMMING BUTTON** on the motor then **PRESS & HOLD** it until the drapery jogs 3 times:

**PROGRAMMING  
BUTTON**



Glydea®



"S" BUTTON  
(PROGRAMMING)

Glydea® ULTRA



All the settings are erased. Limits will have to be re-established.

# QUICK PROGRAMMING FOR OUTDOOR LIGHTING RECEIVER RTS

## PROGRAMMING MODE

### MEMORIZING THE FIRST TRANSMITTER

**STEP 1:** Power up the receiver and **PRESS** the **PROGRAMMING BUTTON** on the Outdoor Lighting Receiver RTS for more than 2 seconds.

**STEP 2:** The programming LED on the receiver will illuminate and the lamp will light for 2 seconds.

**STEP 3:** **PRESS** the **PROGRAMMING BUTTON** on the new transmitter to add it to the receiver. The programming LED on the receiver will blink and the lamp will light indicating the transmitter is memorized.



### ADDING ADDITIONAL TRANSMITTERS TO THE MEMORY

**STEP 1:** **PRESS** the **PROGRAMMING BUTTON** for more than 2 seconds, on a transmitter that is already memorized by the Lighting Receiver. The programming LED on the receiver will light and the lamp will light for 2 seconds.

**STEP 2:** **PRESS** the **PROGRAMMING BUTTON** on the new transmitter to attach it to the receiver. The programming LED on the receiver will blink and the lamp will light indicating the transmitter is memorized.

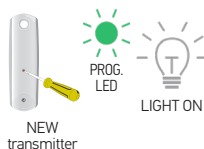
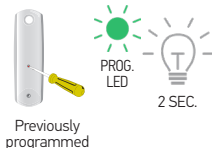

### REMOVING ALL TRANSMITTERS FROM MEMORY

**PRESS & HOLD** the **PROGRAMMING BUTTON** of the receiver for more than 7 seconds until the LED blinks and the light flashes twice. This removes **ALL** memorized transmitters or sensors.

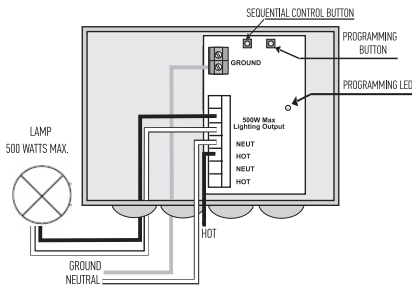

# QUICK PROGRAMMING FOR OUTDOOR UNIVERSAL RECEIVER RTS

## PROGRAMMING MODE

### MEMORIZING THE FIRST TRANSMITTER

#### STEP 1: PRESS the PROGRAMMING BUTTON

on the Outdoor Universal Receiver RTS for more than 2 seconds.

**STEP 2:** The programming LED on the receiver will illuminate and the motor will jog.

#### STEP 3: PRESS the PROGRAMMING BUTTON

on the transmitter to record it to the receiver. The programming LED on the receiver will blink, and the motor will jog indicating the transmitter is memorized.

**STEP 4:** Operate the motor in the DOWN direction to verify the correct direction of operation. The motorized treatment should move down or extend.

**IMPORTANT:** If this is incorrect, turn off power to the receiver and reverse the **RED** and **BLACK** wires. Failure to correct this error will cause damage to awning by extending it during windy conditions.

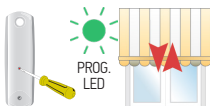
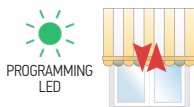

### ADDING ADDITIONAL TRANSMITTERS TO THE MEMORY

#### STEP 1: PRESS the PROGRAMMING BUTTON

for more than 2 seconds, on a transmitter that is already memorized by the Outdoor Universal Receiver. The programming LED on the receiver will light and the motor will jog.

#### STEP 2: PRESS the PROGRAMMING BUTTON

on the Telis transmitter or RTS sensor to be memorized. The programming LED will blink and the motor will jog indicating the device has been memorized.

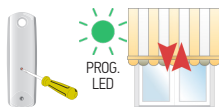

Previously programmed

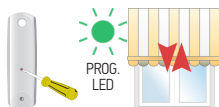

NEW transmitter

### REMOVING ALL TRANSMITTERS FROM MEMORY

**PRESS & HOLD** the **PROGRAMMING BUTTON** of the receiver for more than 7 seconds until the LED blinks and the motor jogs twice.

This removes ALL memorized transmitters or sensors.

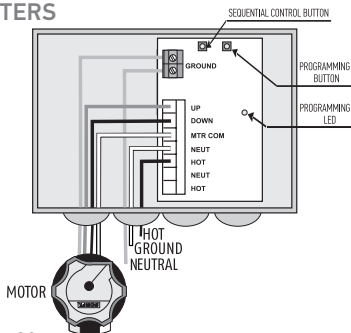

# QUICK PROGRAMMING FOR DIMMABLE LED RTS LIGHT KIT

## GETTING STARTED - INSTALLING THE KIT

### BEFORE YOU BEGIN

Choose a location to mount the receiver. The surface should be reasonably flat and have enough room for easy access to connect the cables on both sides.

If you are connecting a **Sunea® motor with fast connect** to the LED Control, ensure the motor socket is close enough to the motor for the motor cable to reach.

Confirm the interconnect cables will reach. If mounting LED bars on the arms of a long awning, the LED control may need to be mounted closer to the center and a second 15 ft interconnect cable may need to be ordered.

**FASTEN THE LED CONTROL** to the selected surface

- using #8 screws appropriate for the material you are mounting to
- or included double sided tape or with screws through the mounting tabs.

**NOTE: If using the tape, ensure the surface is clean and dry. Double check the mounting location before securing, as the tape attaches strongly.**

### MOUNT THE LED BARS

**If mounting the LED bars on or near an awning,** ensure the desired mounting location has clearance for the LED bars and the cables and LED bars are clear of contact from other moving parts through the full travel of the awning.

**If mounting LEDs to the awning arms,** ensure the LED bars on the front arm and the back arm are close enough to the arm joint that the connector cables are not pulled tight when the arms are extended or retracted and roughly the same distance from the arm joint to reduce bending of the cables.

**NOTE: Make certain to mount the LED bars with the female connector closest to the LED control.**



## QUICK PROGRAMMING FOR DIMMABLE LED RTS LIGHT KIT



Example 1: Utilizing the Sunear® motor the receiver is plugged into the motor and both are powered from the same source via Sunear® power cord. The field instalable motor plug allows the same configuration with other motors.



Example 2: The receiver and motor are plugged separately for power, each directly into the power outlet.

NOTE: The receiver can be used with most 12V LED lights, up to 60w.

### Interconnection Cables (From White sockets on LED control to Female connector on LED bar)

Press the interconnection cables into the connections and then screw down on both the Control and LED bar sides. The connectors are keyed to prevent incorrect connections.

For the awning arm kit, use the 5' connection cable to connect to the close arm and the 25' to connect to the far arm.

***If mounting to the arms on a long awning,*** you may need to mount them in the middle and order another cable (5, 15 and 25 ft. cables are available separately).

Use zip ties or cable guides to secure the cable. ***Leave enough free cable at joints to prevent the cable from pulling tight or bending at a sharp angle.***

***Ensure the cables are free from pinching, pulling or contact with moving parts through the full travel of the awning.***

If only connecting 1 series (string) of LED bars to the LED Control, leave the weather cap tight on the spare socket.

# QUICK PROGRAMMING FOR DIMMABLE LED RTS LIGHT KIT

## CONNECT POWER (Optional - also connect the motor)

*If used with a Sunea® motor with fast connect*, the existing motor power cord can likely be used. Ensure the control is mounted close enough to the motor. Remove the weather cap and screw the motor into the socket.

Connect the power cord into the power connector and twist the locking ring 1/4 turn into locked position.



The fast connect power cord is purchased separately.

Available in three lengths :

10.4 ft. # 9020791

18 ft. # 9020792

24 ft. # 9020793

## PROGRAMMING MODE

### FEEDBACK

On each programming step the LED Control will give a blink of the connected LEDs as feedback to confirm the command was accepted.

If the LEDs are off, the feedback is a blink on and then back off.

If the LEDs are on, the feedback will be a blink off and then back on. Some programming functions give a slow blink 2 to 3 seconds on/off (or off/on as mentioned above) and others will provide a fast blink as feedback.

### POWER UP

When power is first applied to the LED Control, the LEDs will give a slow blink. This is the indication that the LED Receiver is not programmed.

## MEMORIZING THE 1ST TRANSMITTER

**STEP 1:** Power up the LED Control and verify that the LEDs give a slow blink.

**STEP 2: PRESS & HOLD** the **UP** and **DOWN** buttons simultaneously. The LEDs will give a slow blink.

**STEP 3: PRESS & HOLD** the **PROGRAMMING BUTTON** on the transmitter until the LEDs give a slow blink. The transmitter is now programmed.

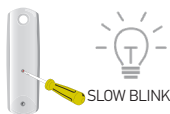

# QUICK PROGRAMMING FOR DIMMABLE LED RTS LIGHT KIT

## ADDING ADDITIONAL TRANSMITTERS (CHANNELS)

A total of 12 RTS transmitters (channels) can be memorized by the LED Receiver

**STEP 1:** With the LEDs OFF, use a previously programmed transmitter and **PRESS & HOLD** the **PROGRAMMING BUTTON** until the LEDs give a slow blink.

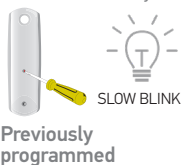

**STEP 2:** BRIEFLY PRESS the **PROGRAMMING BUTTON** of the transmitter you wish to add, the LEDs will give a slow blink. The new transmitter is ready for your use. Both control the LED lights the same way.



## FACTORY RESET

If all programmed transmitters are lost or broken, the LED control can be reset to factory mode to allow a new transmitter to be added.

**If a motor is connected to the LED control, disconnect the motor before starting. Reconnect the motor after the LED control has been reprogrammed.**



1. Power OFF  
for 5 seconds



2. Power ON  
for 10 seconds



3. Power OFF  
for 5 seconds



4. Restore  
power

The LED control should start a slow on/off blink cycle that will continue for 2 minutes if no other commands are given.

While the LEDs are in the on/off blink cycle, **PRESS & HOLD** the **PROGRAMMING BUTTON on the transmitter** until the LEDs give a fast blink on/off and then a second blink on/off and then remain off.



The control is now reset and can be programmed with a new transmitter.

# QUICK PROGRAMMING FOR DIMMABLE LED RTS LIGHT KIT

## FUNCTION



"my" light level

### Setting and using the favorite "my" light level

1. To set the favorite "my" light level use the up or down button to dim the LEDs to the desired light level.
2. **PRESS & HOLD** the **MY/STOP** button until the LEDs blink twice. The favorite "my" level is set. A short press of the **MY/STOP** button will move the light level to the set favorite.

### LED 3 hour Timer

The LED Control has a 3 hour timer that can be enabled or disabled as desired. The timer is disabled in the factory default mode.

With the timer enabled, the control will automatically turn off the LEDs 3 hours after the last command is given.

#### Enable the Timer

Simultaneously press and hold for approximately 7 seconds the **UP, MY and DOWN** buttons until the LEDs give **1 fast blink**.

#### Disable the Timer

Simultaneously press and hold for approximately 7 seconds the **UP, MY and DOWN** buttons until the LEDs give **2 fast blinks**.

Each time the **UP, MY and DOWN** buttons are held for 7 seconds will toggle the timer on or off.

**One blink** = 3 hour timer Enabled

**Two blinks** = 3 hour timer Disabled

BUTTON PRESS	FUNCTION
<b>Short press on UP</b>	LEDs ON 100%
<b>Short press on DOWN</b>	LEDs OFF
<b>Hold the UP</b>	Dim LEDs UP
<b>Hold the DOWN</b>	Dim LEDs DOWN
<b>Hold the MY</b>	Set the favorite light level
<b>Short press on MY</b>	Go to the set favorite level

## QUICK PROGRAMMING FOR RTS REPEATER

The Somfy RTS Repeater can be used in installations to extend the range of the standard Radio Technology Somfy® signal. It will receive the signal from a Telis or similar device and retransmit the signal to a RTS compatible motor or receiver.

Simply plug the receiver into any 120V AC outlet. It should be located at least halfway between the transmitting device (Telis) and receiving device (RTS Motor). The red LED will blink, indicating communication.



## QUICK PROGRAMMING FOR UNIVERSAL RTS INTERFACE (URTSI)

### PROGRAMMING MODE

Set the RTS receiver or motor into its **PROGRAMMING MODE**.

Refer to the installation instructions of the relevant RTS receiver or motor for this procedure.

 **For initial programming, provide power only to the motor or control being programmed.**

Using the rotary switch, select the channels (1-9) to be programmed. Letter A through F stand for channels 10 through 15, 0 for 16. **BRIEFLY PRESS** the **PROGRAMMING BUTTON** (1 sec. max.). The window treatment will jog to indicate the channel has been memorized.



Repeat the steps above for each channel or product to be memorized.

To test the control operation, simply press the **UP, STOP or DOWN** buttons on the front of the control. The window treatment should move appropriately. The LED will flash red to indicate the radio signal has been transmitted.

## MYLINK™ INITIAL SETUP & RTS PROGRAMMING

### PRE-INSTALLATION BEST PRACTICES

1. Confirm that the RTS motorized products are fully operational from at least 1 RTS control and that all the limits are set (including the "my" favorite position if desired).

**NOTE:** The myLink cannot be used to set limits or add/delete RTS transmitters.

2. Make sure that the WiFi network is 2.4 GHz or 5GHz and is using a myLink-supported encryption type (WEP, WPA2, open and mixed mode).

3. Connect your mobile device to the network you want the myLink to join and check the WiFi strength.

4. Know your WiFi network name (SSID) and password (if required).

5. Expect to install 1 myLink interface per zone (16 channels per myLink, 5 channels for V1 - Legacy myLink).

### SETUP

**STEP 1:** Download the free app from the App store or Google Play.



**STEP 2:** Plug the myLink interface into a standard 110V AC outlet. Be sure to place the myLink near the motorized applications you plan to control.

**STEP 3:** Open the app and press **Start new system**

**STEP 4:** Follow the setup prompts. Confirm the status LED is solid red indicating that the myLink is in setup mode.

**STEP 5:** Connect the mobile device to the myLink's WiFi network (ex: Somfy\_1234).

**STEP 6:** Return to the app and press **Search for myLink**

**STEP 7:** In the network dropdown list, choose the network the myLink will join and enter the WiFi network password (if present) and press **Next**

## MYLINK™ INITIAL SETUP & RTS PROGRAMMING

### SETUP CONTINUED

**STEP 8:** The myLink will complete the network auto-configuration process. Once step 4 is complete, click **Continue**.

**NOTE:** Make sure the mobile device rejoins the same WiFi network as the myLink. If not, minimize the app, join the same WiFi network as the myLink and return to the app.

**STEP 9:** Name the myLink and select a room icon. Continue on to **RTS Programming**.

**STEP 10:** From the RTS programming screen, choose from the available application icons. →



Click to choose an RTS product icon

**STEP 11:** Follow the on-screen setup prompts.

- Identify the transmitter that currently controls the motorized product and confirm that it's working properly. Select the channel that operates the product you wish to program.
- Press the program button on the back of the remote until the shade jogs.

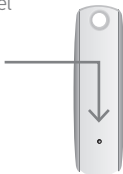

**STEP 12:** Press **Program** on the app and the shade will jog again.

**NOTE:** If the motorized application does not respond to the command, press the **Retry** button to send the signal again.

**STEP 13:** The programming is now complete for that channel. Simply press **Create Group** to program additional motors to the same channel or Press **Done** to add additional channels and name them. Repeat the process to create up to sixteen channels. Once RTS programming is complete, press **Done**

**STEP 14:** The myLink is now configured and ready to use. Scenes and schedules can now be created.

## CREATE AND EXECUTE SCENES

Scenes activate multiple Somfy-powered applications across different channels together, even across multiple myLinks. Each myLink supports up to 25 scenes.

**STEP 1:** Access the scene screen from the toggle button or menu. →

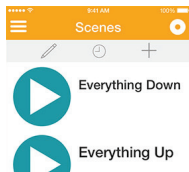

**STEP 2:** Press the plus (+) icon to create a scene and name it.

**STEP 3:** Press the plus icon again to add the motorized products you want associated with the scene.

**NOTE:** If there are multiple myLinks, you will need to choose a myLink first.

**NOTE:** For tablets, drag and drop the command to be added.

**STEP 4:** Once all commands have been added, press **Done** to save.

**STEP 5:** To activate a scene, press its icon.

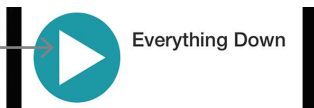

**STEP 6:** To edit a scene, click the pencil (✎) icon and then the scene you wish to edit.

To delete a scene, press the pencil icon then swipe from right to left for the scene to be deleted.

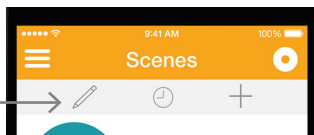

## CREATE AND EXECUTE SCHEDULES

The schedule feature creates timed events with existing scenes. Each myLink supports up to 25 schedules.

**STEP 1:** Access the schedule screen from the scene screen or the menu.

**STEP 2:** Select the clock and then press the plus (+) to create the schedule and name it.

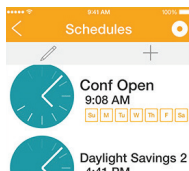



## CREATE AND EXECUTE SCHEDULES CONTINUED

**STEP 3:** Select **Set** to schedule the time and days of activation.

Press back  then back again to save settings.

**NOTE:** Vacation mode will randomly activate the timed event within 15 minutes of its scheduled start time.

**STEP 4:** Press the plus (+) icon to select from available scenes. Up to 5 scenes may be added to each schedule.

**STEP 5:** Press **Done** The time and days associated with the schedule are displayed. The schedule will activate at the appropriate time.

## JOIN EXISTING SYSTEM

The myLink™ allows multiple users to control Somfy-powered products from different mobile devices. They simply need to join the system in a few short steps.

**STEP 1:** First, download the app from the app store or Google play.



**STEP 2:** Connect the mobile device to the same network as the myLink.

**STEP 3:** Open the app, press **Join existing system**

**STEP 4:** Enter the system's 4 digit PIN. Press **Next**

**STEP 5:** The new user now has myLink app control of all paired RTS products, scenes and schedules.

**NOTE:** To invite users, go to menu>mobile pin and press "Share mobile PIN" to generate an invitation email.

**NOTE:** To access RTS programming after initial setup, go to menu>edit and scroll to RTS Programming.

**NOTE:** To add more myLinks, plug the myLink into a standard 110V AC outlet and confirm LED is solid red. Connect the mobile device to the myLink's WiFi network (ex: Somfy\_1234). Open the app and go to menu>add and follow steps 4 through 12 above. Repeat steps 4 - 16.

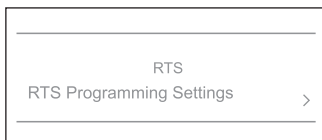

## CHANGING WIFI NETWORK INFORMATION

**STEP 1:** Put the myLink back into setup mode by pressing the programming button on the bottom (or side in V1) of the myLink with a small paper clip or similar item.

**STEP 2:** Confirm the status LED is solid red indicating that the myLink is in setup mode.

**STEP 3:** Connect the mobile device to the myLink's WiFi network (ex: Somfy\_1234)

**STEP 4:** Open the app, Go to menu>edit.

**STEP 5:** Choose a myLink to edit.

**NOTE:** If there is only one myLink, you will go directly to the next step.

**STEP 6:** Select the network field and choose from available WiFi networks.

**STEP 7:** Choose a new network and enter the password if present.

**STEP 8:** Press 

**STEP 9:** The myLink will go through the network auto-configuration to confirm settings. The WiFi network information is now changed.

**NOTE:** If there are multiple myLinks in the system, steps 1-9 must be completed for each one.

## VOICE CONTROL USING AMAZON ALEXA

TO CONNECT YOUR MYLINK SYSTEM WITH THE AMAZON ALEXA SKILL FOLLOW THE STEPS IN THE MYLINK APP.

**Go to Main menu -> Amazon Alexa then click on Link New Account - this will start the account linking wizard.**

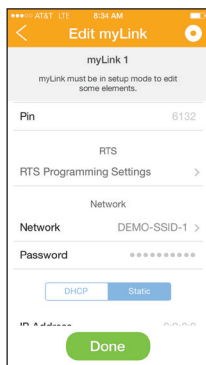

# PROGRAMMING FOR SUNIS INDOOR WIREFREE™ SENSOR

## PROGRAMMING MODE

### ADDING A SUNIS INDOOR SENSOR

 During initial programming, provide power only to motorized window covering being programmed.

**STEP 1:** Carefully remove rear cover to expose sensor control setting panel.

**STEP 2:** Slide the ON/OFF Selector Switch to the ON or  position.

**STEP 3:** Set the motorized window covering into **programming mode** (Refer to the installation instructions of the relevant RTS receiver or motor for this procedure).

**STEP 4:** Using a paper clip, pen or similar device, **BRIEFLY PRESS** the **PROGRAMMING BUTTON** (for 1 second) located on the Sunis light sensor. The motorized window covering will jog to confirm the addition of the new Sunis light sensor.



 Repeat steps 1-3 when multiple motors are required to operate from the Sunis light sensor.

### DELETING A SUNIS INDOOR SENSOR FROM MEMORY

**STEP 1: PRESS & HOLD** the **PROGRAMMING BUTTON** (for 3 seconds) on a previously addressed Sunis Light Sensor or Somfy transmitter (Telis, DecoFlex, etc.)



The motorized window covering will jog to confirm **PROGRAMMING MODE**.

 Step 1 should not be performed with the Sunis intended for deletion.

**STEP 2:** Using a paper clip, pen or similar device, **BRIEFLY PRESS** the **PROGRAMMING BUTTON** (for 1 second) located on the Sunis Light Sensor to be deleted.



The motorized window covering will jog to confirm the deletion of the Sunis light sensor.

 Sunis light sensor **MUST** be free from obstructions in order to correctly sense incoming light. Sill mount may not be suitable for some window installations.

#### SENSOR LOCATION



 Front of Sunis towards outside of window glass

#### WINDOW GLASS MOUNT



 Outside of window glass

#### WINDOW SILL MOUNT



 Outside of window glass

# PROGRAMMING FOR SUNIS INDOOR WIREFREE™ SENSOR

## PROGRAMMING FIGURES

**FIGURE 1**

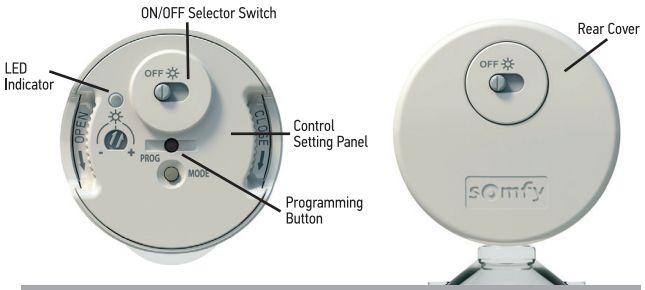

**FIGURE 2**



**FIGURE 3**

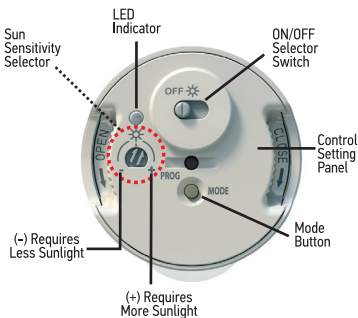

# PROGRAMMING FOR SUNIS INDOOR WIREFREE™ SENSOR

## SETTING THE LIGHT (SUN) SENSITIVITY (THRESHOLD)



**Sunis sensor should be mounted in or near window and exposed to incoming light.**

**STEP 1:** Carefully remove rear cover of Sunis light sensor exposing control setting panel.

**STEP 2:** Slide the ON/OFF Selector Switch to the ON or  position.

**STEP 3: BRIEFLY PRESS** the **MODE BUTTON**. LED Indicator will illuminate for approximately 15 seconds.



*LED Indicator light will remain illuminated for approximately 15 seconds. Should the LED Indicator light extinguish prior to establishing the light sensitivity (threshold) setting, simply press the MODE BUTTON momentarily to reactivate LED light.*

**STEP 4:** Using a small screwdriver or similar device, rotate the Sun Sensitivity Selector to the fully **CLOCKWISE (+)** position. LED Indicator light will illuminate red.



**STEP 5:** Slowly rotate the Sun Sensitivity Selector **COUNTER CLOCKWISE (-)** until the LED Indicator illuminates to a green color. A green colored LED indicates the present light value (threshold). At this value (threshold) the Sunis sensor will provide the necessary **DOWN COMMAND** to the motorized window covering.



## OPERATING MODE



*Default employs output response time delays.*

**STEP 1:** Refer to previous “Setting the Light (Sun) Sensitivity Threshold” instructions.

**STEP 2:** Sunis light sensor will send a **DOWN COMMAND** to the RTS receiver or motor after **5 minutes of sensing light within the set threshold**.

**STEP 3:** Sunis RTS light sensor will send an **UP COMMAND** to the RTS receiver or motor after **30 Minutes of sensing light that HAS FALLEN BELOW THE SET THRESHOLD**.

**GREEN LED:** INDICATES SUN (LIGHT) WITHIN THRESHOLD SETTING

**RED LED:** INDICATES SUN (LIGHT) BELOW THRESHOLD SETTING

# PROGRAMMING FOR SUNIS INDOOR WIREFREE™ SENSOR

## REPLACING THE BATTERY

The Sunis WireFree™ RTS Light Sensor uses a lithium battery (Type: CR2430). LED Indicator Light will illuminate orange when the battery needs replacing.

**STEP 1:** Carefully remove rear cover of Sunis light sensor exposing the control setting panel

**STEP 2:** Firmly grip the molded indentations and rotate control setting panel counter clockwise to open position.

**STEP 3:** Carefully separate from sensor case to expose battery holder.

**STEP 4:** Replace battery with correct rated/type battery. Be certain of battery polarity (+) and (-) when installing new battery.

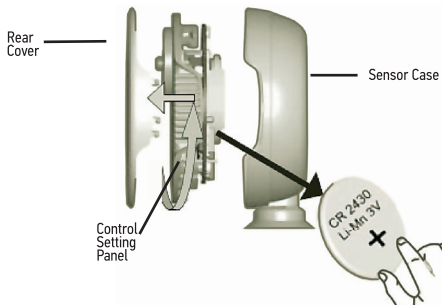

**Do not use any tools when replacing the battery as there is a risk of damaging the sensor circuitry.**

# PROGRAMMING FOR THERMOSUNIS INDOOR WIREFREE™ SENSOR

## PROGRAMMING MODE

### ADDING A THERMOSUNIS INDOOR SENSOR

 During initial programming, provide power only to motorized window covering being programmed.

**STEP 1:** Carefully remove rear cover to expose sensor control setting panel.

**STEP 2:** Set the motorized window covering into **PROGRAMMING MODE** (Refer to the installation instructions of the relevant RTS receiver or motor for this procedure).

**STEP 3:** Slide the ON/OFF Selector Switch to the ON or  position. Sun LED Indicator will illuminate for 5 seconds then extinguish.

**STEP 4: BRIEFLY PRESS** the **PROGRAMMING BUTTON** (for 1 second) located on the control setting panel of the ThermoSunis. The motorized window covering will jog to confirm the addition of the ThermoSunis sensor.

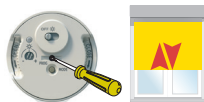

 Repeat steps 1-3 when multiple motorized window coverings are required to operate from the ThermoSunis sensor.

### DELETING A THERMO SUNIS INDOOR SENSOR FROM MEMORY

**STEP 1: PRESS & HOLD** the **PROGRAMMING BUTTON** (approx. 3 seconds) on a previously programmed ThermoSunis or Somfy transmitter (Telis, DecoFlex, etc.) The motorized window covering will jog to confirm PROGRAMMING MODE.



 Step 1 should not be performed with the ThermoSunis intended for deletion.

**STEP 2: BRIEFLY PRESS** the **PROGRAMMING BUTTON** (for 1 second) of the ThermoSunis to be deleted. The motorized window covering will jog to confirm the deletion of the ThermoSunis sensor.

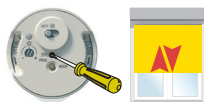

# PROGRAMMING FOR THERMOSUNIS INDOOR WIREFREE™ SENSOR

## PROGRAMMING FIGURES

**FIGURE 1**

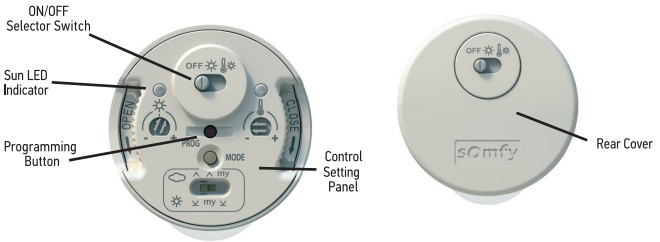

**FIGURE 2**

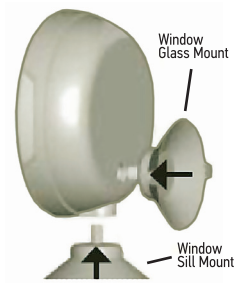

**FIGURE 3**

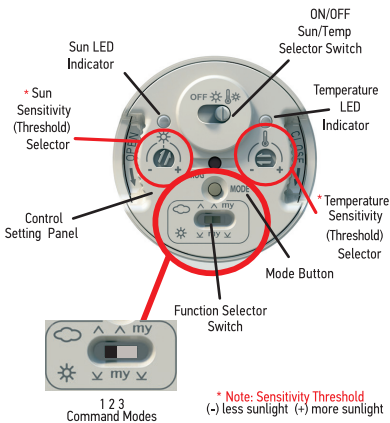



# PROGRAMMING FOR THERMOSUNIS INDOOR WIREFREE™ SENSOR

## SETTING THE LIGHT SENSITIVITY (THRESHOLD)

**STOP** ThermoSunis should be mounted in or near a window and exposed to incoming light.

**!** *The ThermoSunis sensor MUST BE mounted indoors only and should be free from obstructions in order to correctly sense incoming light. Sill mounts may not be suitable for some window installations. Sensor should be mounted in front of all interior window coverings.*

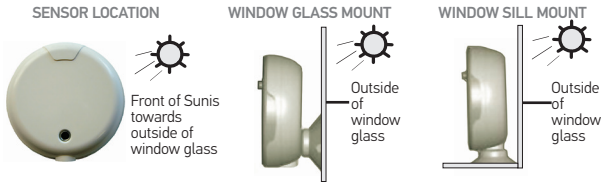

**STEP 1:** Carefully remove rear cover of the ThermoSunis sensor exposing Control Setting Panel.

**STEP 2:** Slide the ON/OFF Selector Switch to the ON or  position. The Sun LED Indicator will illuminate for 5 seconds and then extinguish.

**STEP 3: BRIEFLY PRESS** the **MODE BUTTON** and Sun LED Indicator Light will illuminate for approximately 15 seconds to indicate present threshold setting.

**!** *LED Indicator light will remain illuminated for approximately 15 seconds. Should the LED Indicator light extinguish prior to establishing the light sensitivity (threshold) setting, simply press the MODE BUTTON momentarily to reactivate LED light.*

**STEP 4:** Using a small screwdriver or similar device, rotate the Sun Sensitivity Selector to the fully **CLOCKWISE (+)** position. LED Indicator will remain illuminated red color.



**STEP 5:** Slowly rotate the Sun Sensitivity Selector **COUNTER CLOCKWISE (-)** until the LED Indicator illuminates to a green color. A green colored LED indicates the present light value (threshold). At this threshold, the ThermoSunis sensor will provide the necessary RTS command as selected with the Function Selector Switch.



**GREEN LED:** INDICATES SUNLIGHT WITHIN THRESHOLD SETTING

**RED LED:** INDICATES SUNLIGHT BELOW THRESHOLD SETTING

**!** *Rotating the Sun Sensitivity Selector to a FULL COUNTER CLOCKWISE (-) position will simulate sun if no sun is present. It is not recommended to leave the selector (threshold setting) in this position.*

# PROGRAMMING FOR THERMOSUNIS INDOOR WIREFREE™ SENSOR

## SETTING THE TEMPERATURE SENSITIVITY (THRESHOLD)



**ThermoSunis should be mounted in or near window and exposed to incoming light.**

**STEP 1:** Carefully remove rear cover of the ThermoSunis sensor exposing Control Setting Panel.

**STEP 2:** Slide the ON/OFF Selector Switch to the ON or  position. Sun LED Indicator will illuminate for 5 seconds then extinguish.

**STEP 3: BRIEFLY PRESS** the **MODE BUTTON**. Temperature LED Indicator will illuminate for approximately 15 seconds to indicate present threshold setting.



*LED Indicator light will remain illuminated for approximately 15 seconds. Should the LED Indicator light extinguish prior to establishing the temperature sensitivity (threshold) setting, simply press the **MODE BUTTON** momentarily to reactivate LED light.*

**STEP 4:** Using a small screwdriver or similar device, rotate the Temperature Sensitivity Selector to the fully **CLOCKWISE (+)** position. Temperature LED Indicator will remain illuminated red color.



**STEP 5:** Slowly rotate the Temperature Sensitivity Selector **COUNTER CLOCKWISE (-)** until the LED Indicator illuminates to a green color. A green colored LED indicates the present temperature value (threshold). At this threshold the ThermoSunis sensor will provide the necessary RTS command as selected with the Function Selector Switch.



**GREEN LED:** INDICATES TEMPERATURE WITHIN THRESHOLD SETTING

**RED LED:** INDICATES TEMPERATURE BELOW THRESHOLD SETTING

# PROGRAMMING FOR THERMOSUNIS INDOOR WIREFREE™ SENSOR

## OPERATING MODE

 *Default employs output response time delays.*

**STEP 1:** Slide the Sun/Temp Selector Switch to the desired setting











 = Activation of Window Covering via Sunlight only

 = Activation of Window Covering via Temperature & Sunlight

**STEP 2:** Adjust Sunlight and Temperature Sensitivity (threshold) (Refer to Setting the Sensor Sensitivity (threshold)).

**OR**





Slide the Function Selector Switch to provide the necessary RTS output commands to the window covering.

	*Command Mode 1	Command Mode 2	Command Mode 3
			
After 5 Minutes (within threshold)	 Go to DOWN Limit or Sensor Location	 Go to "my" my Position	 Go to DOWN Limit
After 30 Minutes (below threshold)	 Go to UP Limit	 Go to UP Limit	 Go to "my" my Position

 = Sunlight/Temp sensor within the set "threshold". ThermoSunis will provide an RTS command after approximately 5 minutes of sensing within the set threshold.

 = Sunlight/Temp Sensor below the set "threshold". ThermoSunis will provide an RTS command after approximately 30 minutes of sensing below the set threshold.

 *\*When selected for use with Exterior Rolling Shutter or Exterior Shade Applications, whereby the window covering is mounted externally to the window and ThermoSunis sensor, the window covering will travel to location of sensor only. It is suggested that Mode 1 is used to command no more than 1 window covering per sensor.*

 *\*When selected for use with Interior Window Coverings, the ThermoSunis sensor will provide RTS commands to preset window covering limits*  =  (Go to DOWN Limit)  =  (Go to UP Limit).

# PROGRAMMING FOR THERMOSUNIS INDOOR WIREFREE™ SENSOR

ACTIVATION OF WINDOW COVERING VIA:

## Temperature & Sunlight

 *When  (Sun & Temperature) control is selected, the Temperature threshold setting will TAKE PRIORITY over the Sun Threshold Setting.*

 *Sun Activation (control via sunlight) is not possible unless temperature is within the preset threshold.*

**BRIEFLY PRESS** the **MODE BUTTON**, sun & temperature LED Indicator light will illuminate (for approximately 15 seconds) to indicate preset threshold sensor status.



**GREEN LED:** INDICATES SENSOR WITHIN THRESHOLD SETTING

**RED LED:** INDICATES SENSOR BELOW THRESHOLD SETTING

 *The ThermoSunis RTS Sensor is capable of providing control in accordance to sunlight and temperature conditions only. Once a command is sent, the ThermoSunis will not send another command until there is a change in sunlight or temperature conditions.*

## REPLACING THE BATTERY

The ThermoSunis WireFree™ RTS Light Sensor uses a lithium battery (Type: CR2430). The LED Indicator Light will illuminate orange when the battery needs replacing.

**STEP 1:** Carefully remove rear cover of Sunis light sensor exposing the control setting panel

**STEP 2:** Firmly grip the molded indentations and rotate control setting panel counter clockwise to open position.

**STEP 3:** Carefully separate from sensor case to expose battery holder.

**STEP 4:** Replace battery with correct rated/type battery. Be certain of battery polarity (+) and (-) when installing new battery.

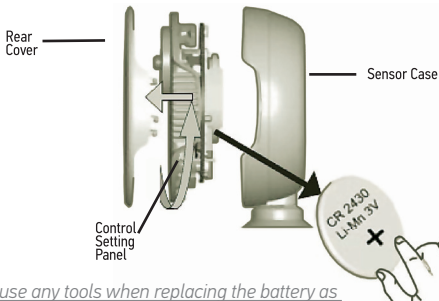

 *Do not use any tools when replacing the battery as there is a risk of damaging the sensor circuitry.*

# PROGRAMMING FOR SUNIS OUTDOOR WIREFREE™ SUN SENSOR

## PROGRAMMING MODE

### ADDING A SUNIS OUTDOOR SENSOR

 During initial programming, provide power only to motorized window covering being programmed.

**STEP 1: PRESS & HOLD** the **PROGRAMMING BUTTON** on the control (transmitter) for 3+ seconds until the motor jogs.



**STEP 2:** Press the **PROG BUTTON** on the Sunis Outdoor.



The green LEDs light and motor jogs.

The Sunis Outdoor is added to the motor.

 A Soliris transmitter must be programmed to the motor(s) to allow the user to Enable/Disable the sun function.

### DELETING A SUNIS INDOOR SENSOR FROM MEMORY

Repeat steps 1 and 2 above.

 If a sensor is physically removed or damaged, it must be cleared from the motor memory.

**To delete all sensors when adding a new sensor** follow Steps 1 and 2 except on Step 2 **PRESS & HOLD** the **PROGRAMMING BUTTON** until the motor jogs twice (approx. 7 seconds). This will clear all sensors.

**To add a new sensor** follow Steps 1 and 2 normally.

### SETTING SUN THRESHOLD LEVEL

The Sun Threshold level can be adjusted up or down by a short press of + or - buttons. For levels 1-4, the red LED will blink 1-4 times to confirm the level.

For levels 5-8, the green LED will blink.

# PROGRAMMING FOR SUNIS OUTDOOR WIREFREE™ SUN SENSOR

## SETTING SUN THRESHOLD LEVEL

Threshold	1	2	3	4	5	6	7	8
Sunlight intensity (kLux)	1	5	10	20	40	55	75	100
LED active	Red				Green			
Number of flashes	*	**	***	****	*	**	***	****

## DEMO MODE

Demo Mode allows the Sunis RTS to be tested with minimal delay times. Pressing the + and - together will cause the Sunis to cycle in and out of Demo Mode.

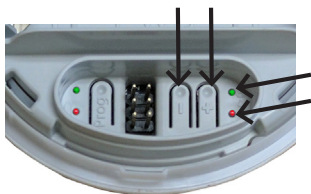

The Red and Green LEDs will alternate when entering Demo Mode and blink together when exiting.

The Sunis Outdoor will automatically time out of Demo Mode after 3 minutes.

Time Delays	No Sun	Sun
Normal Mode	15-30 min	2 min
Demo Mode	15 sec	10 sec

# QUICK GUIDE FOR EOLIS 3D WIREFREE™ WIND SENSOR

## BEFORE YOU BEGIN

Power the motor you are pairing with the sensor.

**Make sure the motor is already adjusted (limits are set) and programmed with an RTS transmitter (you will need a programmed transmitter to add the sensor).**

Make sure the "DOWN" button on the remote extends the awning. If this is incorrect, please refer to relevant motor/receiver instructions to reverse the direction of operation of the awning.



** Failure to correct this error will cause damage to awning by extending it during windy conditions.**

## MOUNTING THE SENSOR

Clear awning of any debris and make sure surface of awning is clean.

Apply tape or use screws to secure the mounting plate to front bar of the awning.

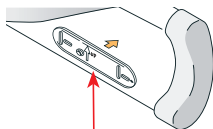

Make sure the arrow on the mounted bracket is pointing upwards.

## ADDING/REPLACING BATTERIES

**NOTE: For optimal performance, batteries should be replaced every season. If the batteries are depleted, the awning will retract every 30 to 60 minutes without wind present.**

**STEP 1:** Carefully remove the sensor housing using a small screwdriver.

**STEP 2:** Install 2 AAA alkaline batteries. Make sure the green LED light blinks (The LED will blink red in sensors sold before 2015). If the LED light does not blink, check batteries for correct polarity.

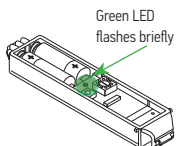
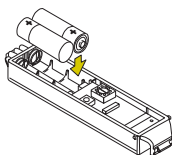
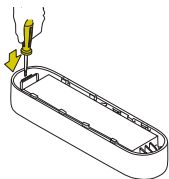

# QUICK GUIDE FOR EOLIS 3D WIREFREE™ WIND SENSOR

## PROGRAMMING MODE

**STEP 1: PRESS & HOLD** the **PROGRAMMING BUTTON** on the back of a remote programmed to the awning until the awning jogs.

**STEP 2: BRIEFLY PRESS** the **PROGRAMMING BUTTON** on the Eolis 3D Sensor until the awning jogs.

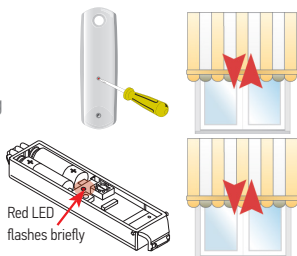

**STEP 3:** Adjust the sensor dial.  
(1= Most sensitive,  
9= Least sensitive)

**STEP 4:** Put the sensor electronics back in the housing and slide the housing back on the mounting plate. Make sure the arrows are facing the same way.

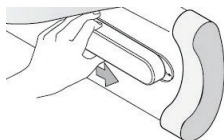
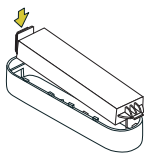
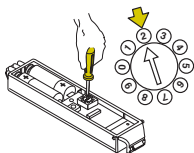

**STEP 5:** Make sure the awning is out. Test the sensor by pushing up and down on the awning front bar or arm until it begins to retract. You can use the remote to stop the awning after 5 seconds (first test mode).

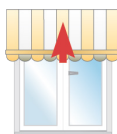
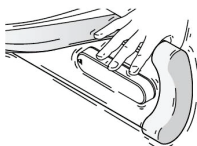
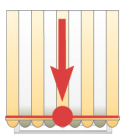

5 sec.



**STEP 6:** Bring the awning back out and test it again. You can use the remote to stop the awning after 5 seconds (second test mode).

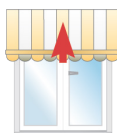
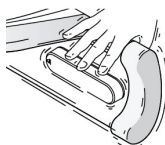
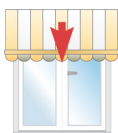



## QUICK GUIDE FOR EOLIS 3D WIREFREE™ WIND SENSOR

**STEP 7:** Make adjustments to the sensitivity if needed and test it again.

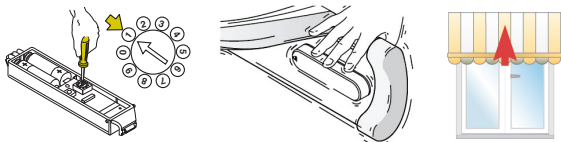

### DELETING THE EOLIS 3D RTS SENSOR FROM MOTOR'S MEMORY

1. Start with a transmitter programmed to the awning.  
**PRESS & HOLD** the **PROGRAMMING BUTTON** on that control until the awning jogs.

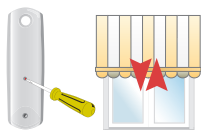

2. Take the Eolis 3D Sensor RTS you want to clear from motor's memory.  
**BRIEFLY PRESS** the sensor's **PROGRAMMING BUTTON**. The LED will briefly flash red and the awning will jog.

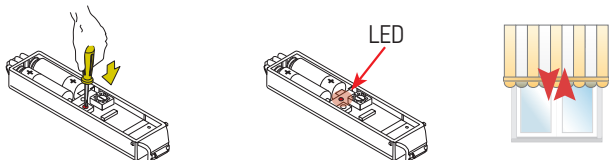

### 3. TO DELETE ALL PROGRAMMED SENSORS FROM THE MOTOR'S MEMORY

**PRESS & HOLD** the **PROGRAMMING BUTTON** on the Eolis 3D for > 7 seconds, motor jogs twice and all sensors are deleted.

This is useful when the Eolis 3D has become defective/water damaged/battery leakage (no need to factory reset the motor).

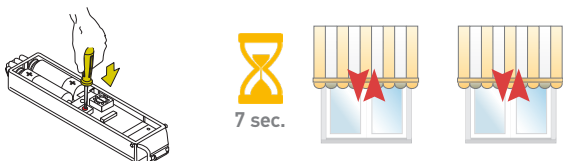

# QUICK GUIDE FOR ONDEIS® WIREFREE RAIN & SUN SENSOR

## BEFORE YOU BEGIN

LED Behavior:

**Normal Operation** - Blinks every 5 seconds when conditions are above the threshold.

**Demo Mode** - Alternate blinks when entering demo mode. Blinks continuously when conditions are above the threshold. LED's blink together when exiting demo mode.

**NOTE:** The sensor does NOT operate under 32 °F/0 °C; standing water, snow or frost DOES NOT activate sensor.

 **IN AWNING MODES:** If the solar battery is not charged, because the charging panel is obstructed and/or not receiving enough light the awning will retract every 60 minutes. Ensure that the solar panel is clean and exposed to daylight.

## GETTING STARTED

Hatch Label

Rain Threshold Dial

Demo Button

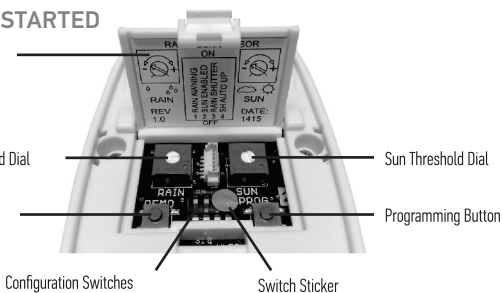

Configuration Switches

Switch Sticker

Sun Threshold Dial

Programming Button

**STEP 1:** Charge the sensor.

For most efficient charging, open the hatch and move all switches to the OFF position.

**NOTE:** The mode must be selected and the sensor left in full sunlight to boot up before programming.

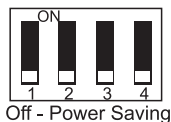

**STEP 2:** Confirm RTS motorized window coverings are operating properly from an RTS control. The UP command should send the awnings IN and screens/shutters UP.

(To change the direction please follow the awning instructions)

**STEP 3: CHOOSE SENSOR OPERATION MODE.** The default setting is Awning Rain. For detailed explanations of operation modes, refer to Operation Modes on reverse.

**NOTE:** A Soliris transmitter (1810647 or 1811243 – not included) is required for Awning Sun and Awning Rain & Sun operation modes.

# QUICK GUIDE FOR ONDEIS® WIREFREE RAIN & SUN SENSOR

## STEP 4: Select sensor threshold settings

### a. Factory Default:

- Rain: 9 o'clock (arrow pointing left)
- Sun: 12 o'clock (arrow pointing up)

### b. More sensitive: turn left

- Very light rain/heavy mist/heavy condensation
- Heavy cloud cover (.5 klux)

### c. Less sensitive: turn right

- Very heavy rain
- Direct summer sun, no cloud cover (55 klux)

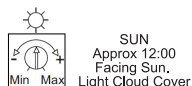
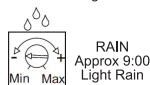
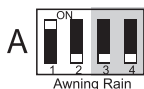

## STEP 5: Program the sensor to the motor(s)

1. **PRESS & HOLD** the **PROGRAMMING BUTTON** on the RTS transmitter until the motor jogs, confirming that the motor is in **PROGRAMMING MODE**.

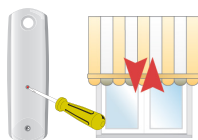

2. **BRIEFLY PRESS** the sensor's **PROGRAMMING BUTTON** – the motor will jog again.

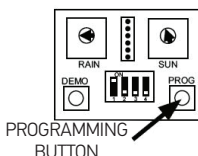

**STEP 6:** To confirm settings, put sensor into demo mode to test rain/sun sensing without standard wait times.

a. **BRIEFLY PRESS** and release the **DEMO BUTTON**. The sensor's LEDs will alternate blink. IN AWNING MODES the associated motor(s) will jog.

b. **DEMO MODE** will time out after 2 minutes. To exit demo mode, press the **DEMO BUTTON** again.

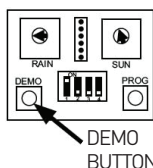

## SENSOR TIME DELAYS

	DEMO MODE	NORMAL MODE
Rain present	0 sec (Up-Locked)	0 sec (Up-Locked)
Rain absent	3 sec (Unlocked)	5 min (UnLocked)
Sun present	10 sec (DOWN)	2 min (DOWN)
Rain absent	15 sec (UP)	15-30 min (UP)

# QUICK GUIDE FOR ONDEIS® WIREFREE RAIN & SUN SENSOR

**STEP 7:** Mount the sensor for maximum exposure to rain and/or sun.

- For best sun protection, sensor should be mounted facing same direction as the associated motorized window coverings.
- For best rain protection, sensor should be exposed to as much rain as possible.
- There are three different mounting options possible using included mounting plate and bracket: vertical mount, pole mount (using zip ties, not included) and gutter mount.

## POLE AND WALL MOUNT

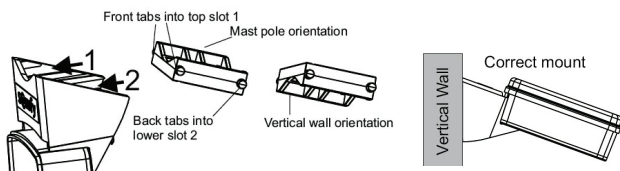

The mounting bracket is released by pushing the bracket clips down gently towards the main body of the sensor and sliding out the mounting bracket.

To replace the mounting bracket, press the bracket clips down gently towards the main body of the sensor and slide in the mounting bracket, making sure the front tabs move into the top slot and the back tabs into the lower slot.

## GUTTER MOUNT

Securely attach rain sensor mounting plate to aluminum gutter mount bracket using flat head screws and nylon locking nuts. Slide gutter mount bracket over gutter lip and secure with socket-head screws.

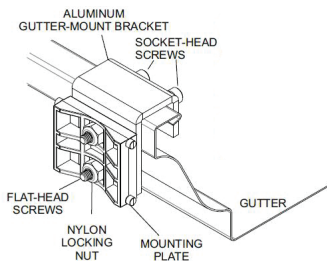

**NOTE: IN AWNING MODE** if the sensor is removed from a job site, it must be deleted from the motor's memory (Page 131). If the sensor is removed without deleting it from the motor's memory, the awning will retract at regular intervals. The sensor must also be deleted from the motor's memory before switching from Awning to Shutter/Screen mode.

# QUICK GUIDE FOR ONDEIS® WIREFREE RAIN & SUN SENSOR

## OPERATION MODE



**Important:** A programmed sensor must be deleted from the motor's memory before it is changed from Awning to Shutter/Screen mode or removed from the job site. Do not change between Awning and Shutter/Screen modes without deleting the sensor from the motor's memory first (to delete the sensor see Page 131).

### AWNING MODES (SENSOR MODES)

#### A. Awning Rain (factory default)

- Rain over threshold: sends awning in
- Awning is locked until 5 minutes after last rain over threshold detected

NOTE: Standing water, snow or frost DOES NOT lock the sensor.

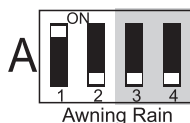

#### B. Awning Sun

NOTE: A Soliris transmitter (1810647 or 1811243 – not included) is required to activate the motor's sun function.

- Sun over threshold (for 2 minutes): sends awning out
- Sun under threshold (for 15-30 minutes): sends awning in

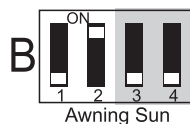

#### C. Awning Rain & Sun

NOTE: A Soliris transmitter (1810647 or 1811243 – not included) is required to activate the motor's sun function

- Rain over threshold: sends awning in
- Awning is locked until 5 minutes after last rain over threshold detected, even to sun commands
- Sun over threshold (for 2 minutes): sends awning out
- Rain & Sun over threshold: sends awning in
- Rain & Sun under threshold (for 15-30 minutes): sends awning in

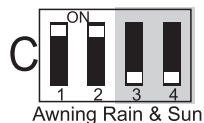

#### D. Awning Sensor Test

Allows testing of the sensor programmed to the motor. In this mode, pressing the DEMO button will extend the awning. This mode is for testing only.

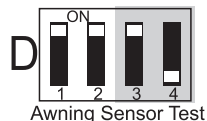

**Do not leave the unit in TEST mode for normal operation.**

# QUICK GUIDE FOR ONDEIS® WIREFREE RAIN & SUN SENSOR



**Important: Prior to switching from Awning to Shutter/Screen mode the programmed sensor must be deleted from the motor's memory. Do not change between Awning and Shutter/Screen modes without deleting the sensor from the motor's memory first (to delete the sensor see Page 131).**

## SHUTTER/SCREEN MODES (TRANSMITTER MODES)

Remove switch sticker to access shutter settings

**NOTE: A Soliris transmitter is not required for Shutter/Screen Rain operation modes.**

### E. Shutter/Screen Rain

- Rain over threshold: sends shutters/screens down
- Rain doesn't lock the motor – transmitter commands will still work.
- Will not send another command until rain falls below the threshold for 5 min and then goes above again

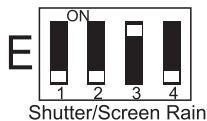

### F. Shutter/Screen Rain & Sun

- Rain over threshold: sends shutters/screens down
- Shutter/screen will lock out sun commands until 5 minutes after last rain over threshold is detected; transmitter commands will still work
- Sun over threshold (for 2 minutes): sends shutters/screens down
- Sun under threshold (for 15 minutes): sends shutters/screens up

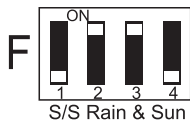

### G. Shutter/Screen Rain & Auto Up

- Rain over threshold: sends shutters/screens down
- Rain doesn't lock the motor – transmitter commands will still work
- Rain under threshold (for 5 minutes): sends shutters/screens up

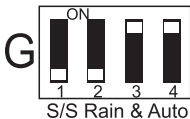

### H. Shutter/Screen Transmitter Test

- Allows testing of the sensor programmed to the motor. In this mode, pressing the DEMO button will extend the awning. This mode is for testing only.

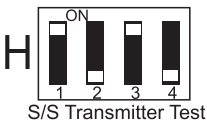

**Do not leave the unit in TEST mode for normal operation.**

## QUICK GUIDE FOR ONDEIS® WIREFREE RAIN & SUN SENSOR

### DELETING THE ONDEIS® RTS SENSOR FROM MOTOR'S MEMORY

**NOTE:** If the sensor is removed from a job site, it must be deleted from the motor's memory. If the sensor is removed without deleting it from the motor's memory, the awning will retract at regular intervals.

The sensor must also be deleted from the motor's memory before switching between awning and shutter/screen modes.

1. Start with a transmitter programmed to the same awning, screen or shutter the sensor operates. **PRESS & HOLD** the **PROGRAMMING BUTTON** of that control until the motor jogs.

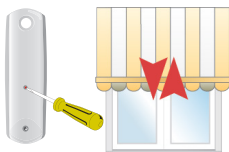

2. Take the Ondeis® Sensor you want to clear from the motor's memory and **BRIEFLY PRESS** the sensor's **PROGRAMMING BUTTON**. The motor will jog again confirming the deletion.

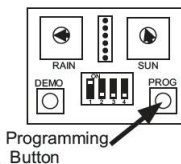

### 3. TO DELETE ALL PROGRAMMED SENSORS FROM THE MOTOR'S MEMORY

**PRESS & HOLD** the sensor's **PROGRAMMING BUTTON** for > 7 seconds; the motor jogs twice and all sensors are deleted.

This is useful when the sensor has become defective/water damaged/battery leakage (no need to factory reset the motor).

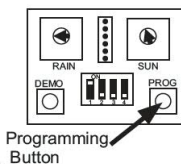

7 sec.

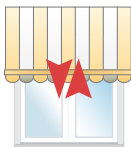

# PROGRAMMING FOR TELIS 16 RTS

## DESCRIPTION

The Telis 16 RTS remote control allows you to control up to 16 end-products or groups of end-products using Radio Technology Somfy® (RTS).



### BEFORE YOU BEGIN

We recommend that each motor is programmed in advance using an individual Telis 1 RTS transmitter and that the limits of each motor are set. However, like any RTS remote control transmitter, the Telis 16 RTS can be used for motor programming operations (limit switch adjustment, etc.)

After 2 minutes of inactivity, the Telis 16 RTS screen automatically goes to SLEEP MODE. When the screen is off, first press any button to turn it on.

## NAMING A CHANNEL

**STEP 1:** Select the channel you want to customize using the **ARROW buttons** ( ◀ or ▶ ).

**STEP 2: PRESS & HOLD** the **SELECTION button** ( ● ) until SET appears on the screen, **set mode** is activated.

The flashing icon (shades/shutter, rolling shutters/skylight shades and awning) are displayed.

Use **ARROW buttons** ( ◀ or ▶ ) to scroll through the choices.



Selection button



**STEP 3: BRIEFLY PRESS** the **SELECTION button** ( ● ) to save the icon displayed and move to the first character.

**STEP 4:** Select the location of the character to be edited using the navigation buttons ◀ or ▶. The flashing hyphen corresponds to the character to be edited.

**STEP 5: BRIEFLY PRESS** the **SELECTION button** ( ● ) to edit the character in this location.

**STEP 6:** The character flashes to select another character, press the **ARROW buttons** ( ◀ or ▶ ).



# PROGRAMMING FOR TELIS 16 RTS

**STEP 7: BRIEFLY PRESS** the **SELECTION button** to save the character displayed and move to the next character.

**STEP 8:** Repeat steps 4 to 7 for each of the characters in the channels name.

**STEP 9: PRESS & HOLD** the **SELECTION button** until SET is no longer displayed on the screen, **set mode** is deactivated, and the Telis 16 RTS returns to **manual mode**.



*The characters (7 letters +1 number) can be alphabetic (A to Z) or numeric (0 to 9).*



*Naming Other Channels: Repeat steps 1 to 9 for each channel you want to customize.*

## ADDING OR DELETING TRANSMITTER/CHANNEL



*The procedure for assigning window coverings to the channels of the Telis 16 RTS and deleting them is identical.*

**STEP 1: PRESS & HOLD** the **PROGRAMMING BUTTON** on the individual RTS transmitter that has already been programmed until the window covering jogs: **PROGRAMMING MODE** is activated for 2 minutes.

**STEP 2:** Use the **ARROW buttons ( ◀ or ▶ )** to select the channel on the Telis 16 RTS to be programmed.

**STEP 3: BRIEFLY PRESS** the **PROGRAMMING BUTTON** on the Telis 16 RTS. The window covering jogs back and forth and it is assigned to or deleted from the chosen channel on the Telis 16 RTS.



*In order to assign or delete the window covering from other channels, repeat steps 1 to 3, selecting another channel.*

# PROGRAMMING FOR TELIS 1 CHRONIS RTS

The Telis 1 Chronis RTS® combines the functionality of a single channel RTS hand-held control with the convenience of a programmable timer. This control option is compatible with all Radio Technology Somfy® (RTS) motorized applications and offers simple programming and easy operation.

## MAIN FUNCTIONS

The timer function has 2 commands / day:  
One up & one down (default up @ 7:30 am & down @ 8:00 pm).

2 possible schedules:

- Daily schedule - same cycle everyday.
- Weekday & Weekend schedule: 2 UP and DOWN times (1 for weekdays & 1 for weekends).

**Quick Set function:** A simple press and hold of the **UP** or **DOWN** button for 11 seconds saves the current time as the opening or closing time of motorized applications every day.

**Vacation mode:** Varies scheduled time to simulate a lived-in look (randomly opens and closes from 0 to + 30 minutes).

## ADDITIONAL FUNCTIONS

- Pre-programmed in factory : Daily programming : UP at 7:30 am /DOWN at 8:00 pm.
- Ability to manually modify scheduled times via selection button & navigation keys.
- Automatic adjustment for daylight savings time.
- Low battery indication - customers are notified when batteries need replacing (AAA batteries).



## SET-UP

Before using the Telis 1 Chronis RTS, all motor limits must be set and fully operational with another RTS transmitter.

 **After 2 minutes of inactivity, the Telis 1 Chronis RTS screen switches to sleep mode. Press any button to turn it back on.**

# PROGRAMMING FOR TELIS 1 CHRONIS RTS

## BATTERY INSTALLATION

- Remove the battery cover from the back of the Telis 1 Chronis RTS and insert included 2 AAA (LR3) batteries following the polarity indicated.
- Replace the cover.
- Turn on the Telis 1 Chronis RTS by briefly pressing any button.

Replace the batteries when the  symbol appears on the display. Never use rechargeable batteries.

 *If there is no power supply for an extended period of time (batteries are discharged or removed), the general parameters of the remote will need to be reset. However, the automatic schedules are saved in memory.*



## ADDING OR DELETING A TELIS 1 CHRONIS RTS

*The procedure for assigning an end-product to the Telis 1 Chronis RTS and deleting it is the same.*

**STEP 1:** Using a paperclip or pen, **PRESS & HOLD** the **PROGRAMMING BUTTON** on a previously addressed RTS transmitter until the window covering jogs.

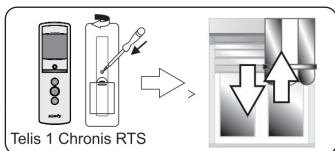

 *Step 1 should not be performed with the Telis 1 Chronis RTS intended for deletion.*

**STEP 2:** Select the Telis 1 Chronis RTS (single channel) to be added or deleted.

**STEP 3: PRESS & HOLD** the **PROGRAMMING BUTTON** on the Telis 1 Chronis RTS until the window covering jogs. The Telis 1 Chronis RTS is now added or deleted from the window covering memory and will now operate the window covering.

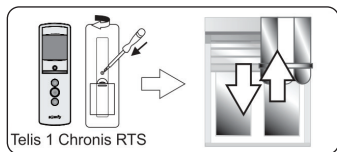

 *Telis 1 Chronis RTS programming is now complete. The programmed window covering will now automatically activate at the pre-programmed UP and DOWN times of 7:30am and 8pm respectively.*

# PROGRAMMING FOR TELIS 1 CHRONIS RTS

## SETTING THE GENERAL PARAMETERS

When the batteries are first installed, the transmitter will enter programming mode. "SET" and "YEAR" appear on the screen, with the year flashing.

- Press the **ARROW buttons ( ◀ or ▶ )** to modify the parameter. The parameter to be set will be flashing (press and hold the button to scroll the characters faster).
- To save the parameter and move to the next parameter, briefly press the selection button ( ● ).

 To access and modify the general parameters press and hold the selection button ( ● ) for 7 sec until the screen displays "YEAR".

The parameters appear in the following order:



Current year

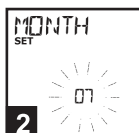

Number of current month



Number of current day

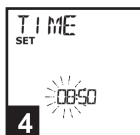

Current hour



Minutes



Country of residence

Daily/Weekend



Daily/Weekend



Confirms last parameter

Select the work/daily days you want to program using the arrow buttons ( ◀ or ▶ ). All days are work days unless deselected. To deselect a day briefly press and release the selection button ( ● ).

 Press and hold the selection button ( ● ) to exit programming mode at any time.

# PROGRAMMING FOR TELIS 1 CHRONIS RTS

## EDITING PRE-PROGRAMMED SCHEDULES

### Schedule Quick Set

The **quick set** feature allows users to change schedule activation UP and DOWN times to the current time of day.

**STEP 1:** Press the **ARROW** buttons ( ◀ or ▶ ) to select the (UP) or (DOWN) time you wish to edit.

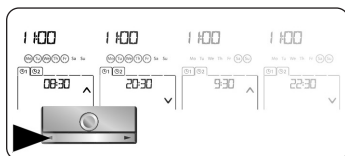

**STEP 2: PRESS & HOLD** the ( ⬆ UP ) to modify the UP time or ( ⬇ DOWN ) to modify the DOWN time for 11 seconds.

The word SET will appear and the schedule time will change to the current time and start to flash.

**STEP 3:** The word SET will disappear. Release the ( ⬆ UP ) or ( ⬇ DOWN ) button. The new schedule time is now saved.

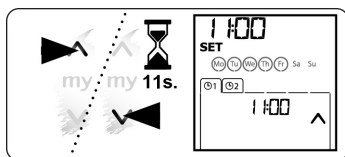

*Do not release the ( ⬆ UP ) or ( ⬇ DOWN ) button until the word SET disappears or the new schedule will not be saved.*

# PROGRAMMING FOR TELIS 1 CHRONIS RTS

## EDITING SCHEDULES

1. Press the **ARROW buttons ( ◀ or ▶ )** to select the time you wish to edit.
2. **PRESS & HOLD** the **SELECTION button ( ● )** until the word **EDIT** appears and flashes.
3. Press the **SELECTION button ( ● )**; the hour will flash.
4. Use the ( < or > ) button to set the hour.
5. Press the **SELECTION button ( ● )** to confirm the hour; the minutes will flash.
6. Use the buttons to change the minutes.
7. Press the **SELECTION button ( ● )** to confirm the time. The new activation time is now saved.

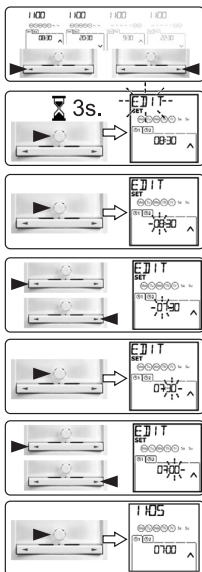

## DELETING AN ACTIVATION TIME

1. Press the **ARROW buttons ( ◀ or ▶ )** to select the time you wish to delete.
2. **PRESS & HOLD** the **SELECTION button ( ● )** until the word **EDIT** appears and flashes.
3. Press either ( < or > ) button until **DELETE** appears.
4. Press the **SELECTION button ( ● )** to delete selected activation time and to confirm changes.

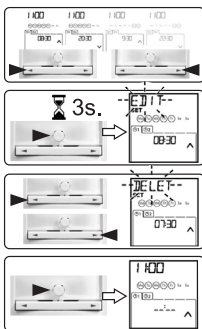

## VACATION MODE

**Vacation mode** varies schedule times to simulate a lived-in look (randomly opens and closes window coverings from 0 to 30 minutes from the set activation time).

- To activate or deactivate Vacation Mode, press and hold both ( < and > ) until the ( ■ ) symbol appears or disappears.

# TROUBLESHOOTING RTS MOTORS

## BEFORE YOU CALL FOR SERVICE

- Verify the motor is powered
- Verify the motor is installed correctly inside the tube (Crown & Drive correctly installed)
- Verify the motor limits are set correctly
- Allow time for the motor to cool off after continuous operation (we recommend at least 15 minutes). Motors are equipped with a thermal shut off for safety.
- Verify all sensors on location are within RTS range and are working properly
- Check the transmitter batteries (LED should flash with a button press)
- Verify that the transmitter you are using is properly programmed into the motor's memory
- Do not cut power cable shorter than 12 inches (the power cable acts as an antenna)
- The mounting distance between 2 motor heads must exceed 19 inches to avoid radio interference.
- Verify there is no outside radio interference on location (some examples would be airports, marinas, army bases, weather or security systems).
- In programming mode and limit adjustment mode the radio reception of the motor is reduced. It is necessary to move the transmitter closer to the motor head during this time.

Please visit the technical support section on

[www.somfysystems.com](http://www.somfysystems.com) and [somfypro.com](http://somfypro.com)

or call Somfy Customer Service at **877-22-SOMFY**.

and don't forget to download the app!



**SOMFY®** has been improving everyday life for more than 270 million people by designing and manufacturing intelligent motorization solutions for interior window coverings and exterior solar protections. Somfy innovates to automate and connect shades, blinds, draperies, awnings, rolling shutters, exterior screens & pergolas for commercial and residential buildings in 58 countries across the globe. With 200+ million motors produced over the last half century, Somfy is committed to creating reliable and sustainable solutions that promote the best way of living and well-being for all.

**SOMFY SYSTEMS INC  
SOMFY NORTH AMERICAN HEADQUARTERS**

121 Herrod Blvd.  
Dayton, NJ 08810  
P: (800) 22-SOMFY (76639)  
NJ: (609) 395-1300  
F: (609) 395-1776

**FLORIDA**

1200 SW 35th Ave.  
Boynton Beach, FL 33426  
P: (800) 22-SOMFY (76639)  
F: (561) 995-7502

**CALIFORNIA**

15301 Barranca Parkway  
Irvine, CA 92618-2201  
P: (800) 22-SOMFY (76639)  
F: (949) 727-3775

**SOMFY ULC**

**SOMFY Canada Division**

6411 Edwards Blvd  
Mississauga, ON L5T 2P7  
P: (800) 66-SOMFY (76639)  
CN:(905) 564-6446  
F: (905) 238-1491

[www.somfysystems.com](http://www.somfysystems.com)

A BRAND OF **SOMFY** GROUP

**somfy®**