

# **Duette® & Applause® EasyRise™ Honeycomb Shades Field Repair Manual**

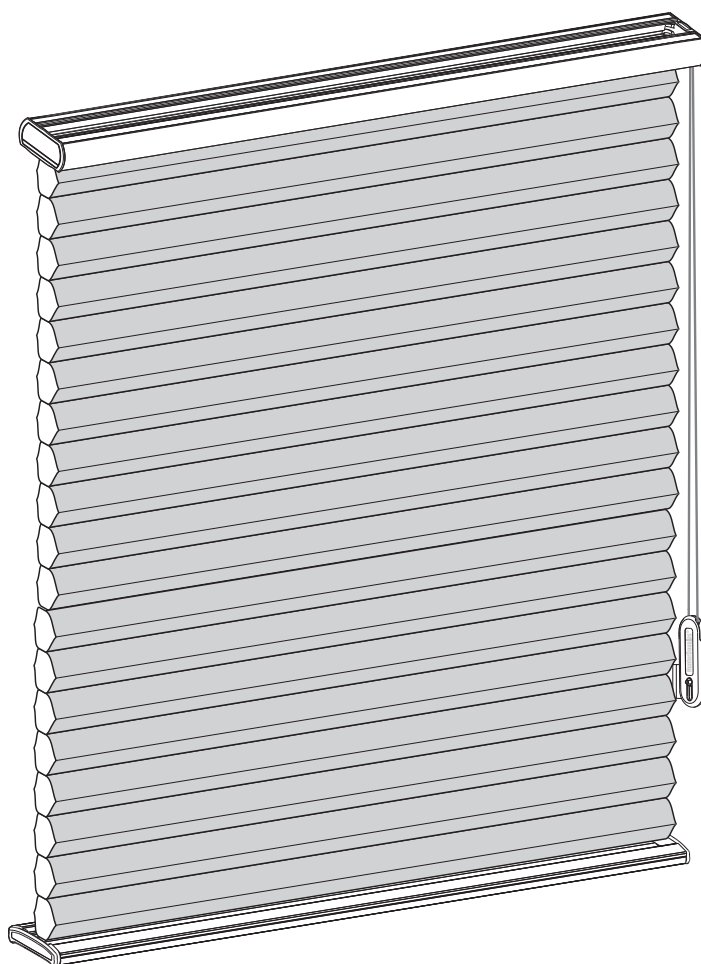

- **Replace the Cord Loop**
- **Replace the Clutch**
- **Replace the Spool Assemblies**



***(For EasyRise Lifting Systems prior to May 2009)***

# Table of Contents

- Component Kits ..... 3**
- Remove The Shade, Clutch, And Shaft ..... 4**
- Replace The Cord Loop..... 5**
- Replace The Clutch ..... 6**
- Replace The Spool Assemblies ..... 7**
- Reassemble And Adjust The Shade..... 10**
- Attach The Universal Cord Tensioner..... 13**

# Component Kits

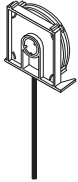
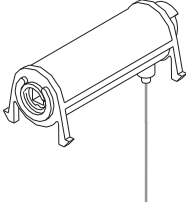
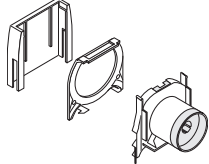
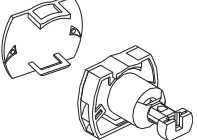
The repair kit you were supplied may contain one or more of the following components:

Item	Quantity	For What Problem
Cord Loop 	1	Broken cord.
Tape Spool Assemblies with Buckles/Pocket Assemblies 	*	Broken lift tape.
Cord Spool Assemblies with Ferrule/Pocket Assemblies 	*	Cord is broken or cord is tangled inside.
$\frac{3}{4}$ " Clutch 	1	Shade doesn't raise or lower, or cover breaks.
$\frac{3}{8}$ " Clutch 	1	Shade doesn't raise or lower.
Threading Tool 	1	Tool used for rethreading the shades.

\* The number of units may vary depending upon how many rout holes are in the shade.

# Remove the Shade, Clutch, and Shaft

## 1. Remove the shade from the window. Be careful not to scratch the headrail.

$\frac{3}{4}$ " Shade Mounting Bracket

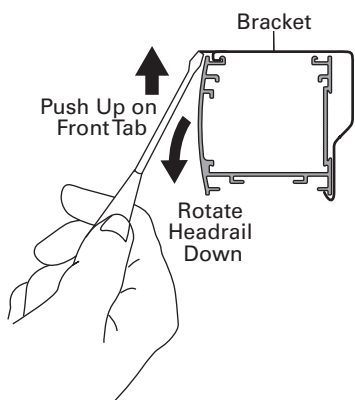

- Lower the shade about 4".
- Using a flat blade screwdriver, push up on the front tab of the mounting bracket to release the front of the headrail.
- Rotate the headrail downward and out from the bracket.

$\frac{3}{8}$ " Shade Mounting Bracket

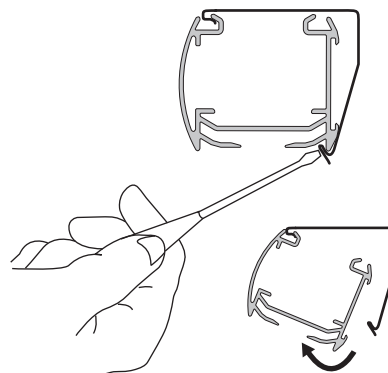

- Lower the shade about 4".
- Push the bottom tab of the mounting bracket to release the back of the headrail.
- Rotate the back of the headrail forward and out from the bracket.

## 2. Remove the clutch and metal shaft from the headrail.

$\frac{3}{4}$ " Clutch and Shaft

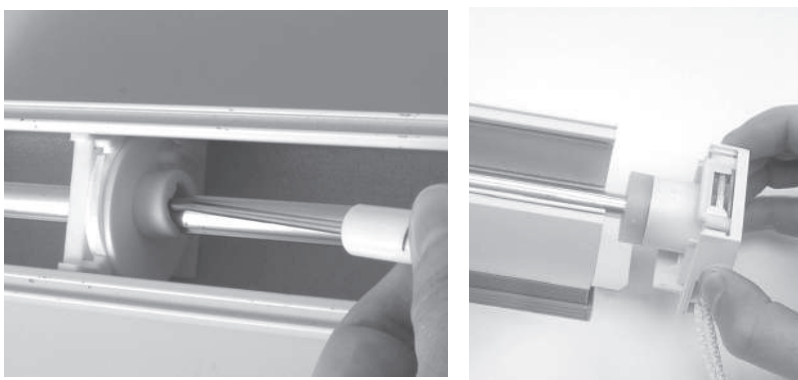

$\frac{3}{8}$ " Clutch and Shaft

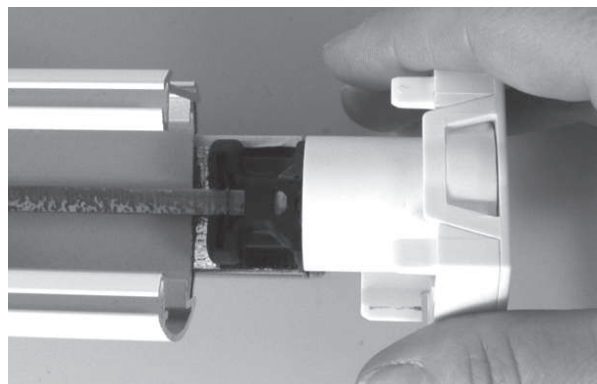

When removing the clutch, the metal shaft, attached to the clutch, will also slide out.

To remove the shaft completely:

- $\frac{3}{4}$ " Clutch: Take the clip off the shaft, then slide out the shaft.
- $\frac{3}{8}$ " Clutch: Slide the shaft through the retainer clip.

# Replace the Cord Loop

## 1. Remove the clutch cover from the clutch.

$\frac{3}{4}$ " Clutch Cover

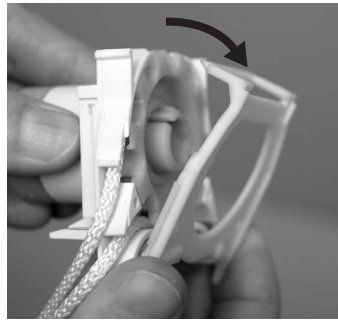
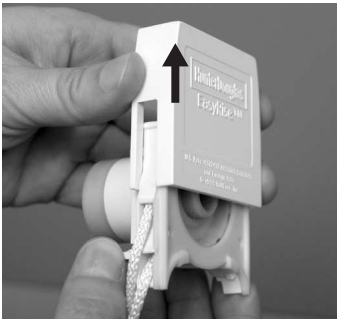

$\frac{3}{8}$ " Clutch Cover

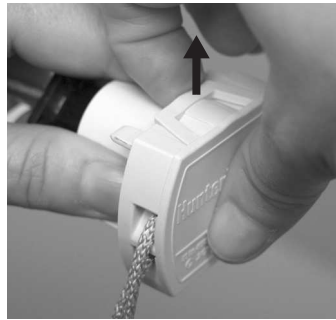

## 2. Remove the old cord loop.

Determine if the clutch is on the left or right side of the shade. This will help in threading the cord onto the clutch.

$\frac{3}{4}$ " Clutch

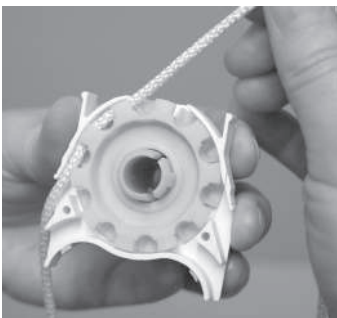
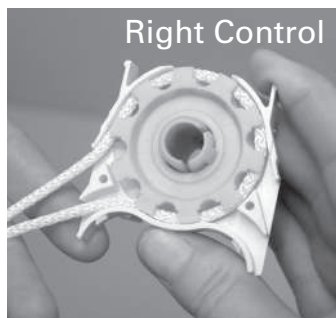
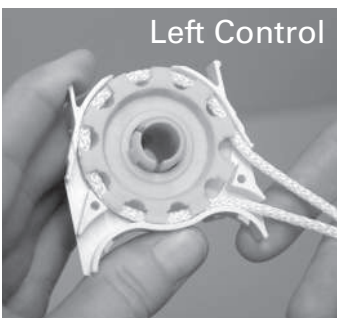

$\frac{3}{8}$ " Clutch

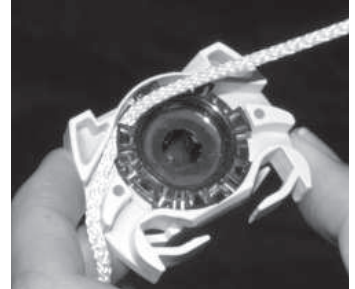
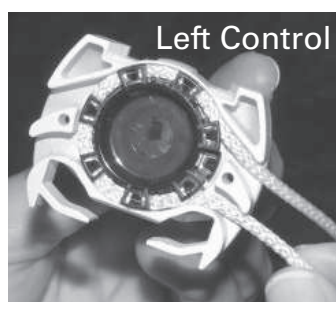

- Detach the old cord from the clutch assembly by pulling one side of the cord loop up from the first set of gear teeth.
- Slowly rotate the teeth counterclockwise while pulling upward on the cord. Be careful to rotate the teeth of the clutch only, not the entire clutch assembly.
- Continue to rotate the gear wheel until the cord is free.

**Note:** If you are replacing a clutch, keep the cord from the old clutch for use on the new clutch.

3. Thread the new cord loop onto the clutch by engaging the teeth on the gear wheel and pulling the cord around. Make sure the cord exits the clutch on the same side as it did originally.
4. After replacing the cord, reinstall the clutch cover and end cap cover (see Step 1 above).

# Replace the Clutch

The new clutch does not come with a cord attached. Before replacing the old clutch, you will need to remove the cord from the old clutch and thread it onto the new clutch (see Page 5).

## 1. Slide the clutch off of the metal drive shaft.

Use needlenose pliers to pinch the metal retainer clip, releasing its grip on the shaft. While pinched, pull the metal shaft out from the clutch.

$\frac{3}{8}$ " Clutch

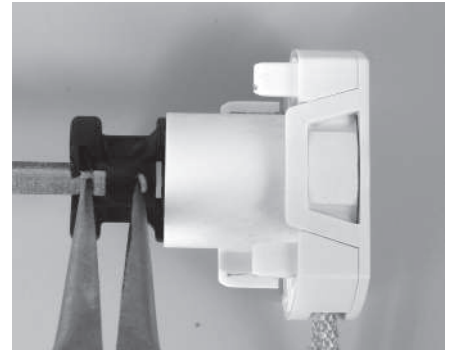

## 2. Align the new clutch to the metal drive shaft and seat it completely.

$\frac{3}{4}$ " Clutch and Shaft



$\frac{3}{8}$ " Clutch and Shaft

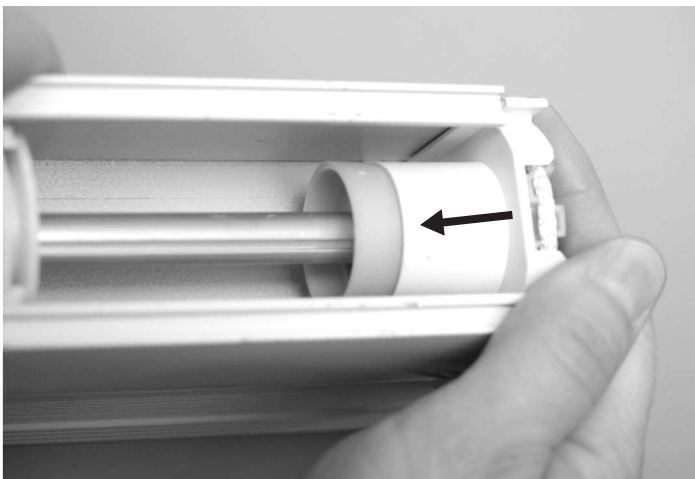
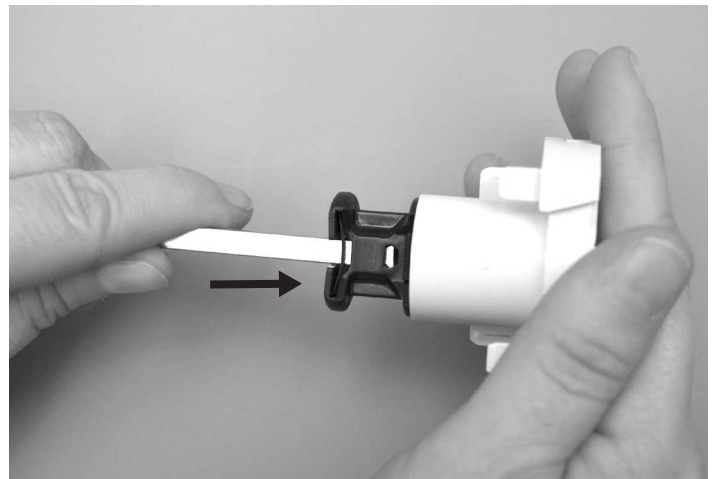

# Replace the Spool Assemblies

1.  $\frac{3}{4}$ " Clutch: Remove the buckles from the pockets in the bottom rail.

$\frac{3}{8}$ " Clutch: Remove the ferrules from the pockets in the bottom rail.

**DO NOT REMOVE THE POCKETS.**

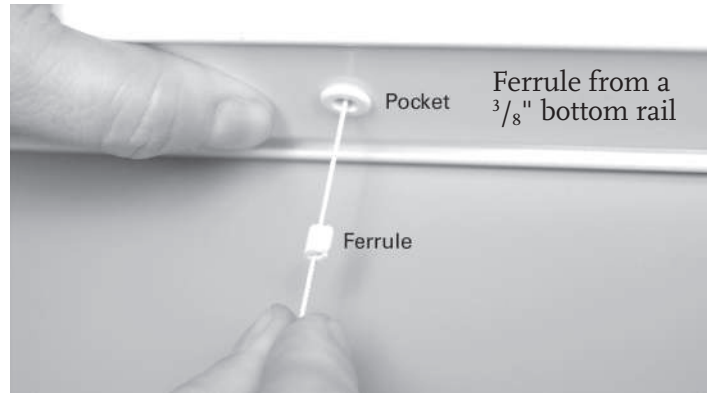
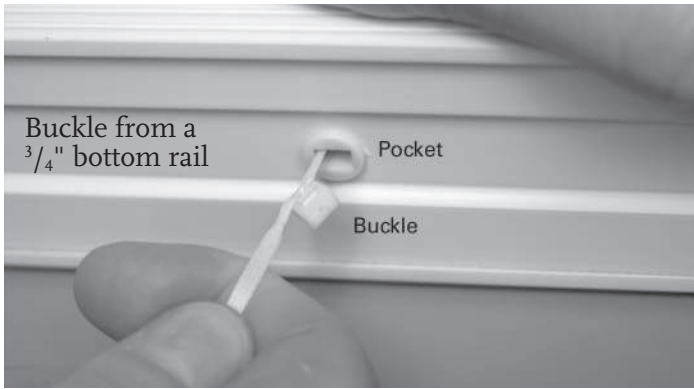

2. Undo the tapes or cords from the buckles or ferrules.

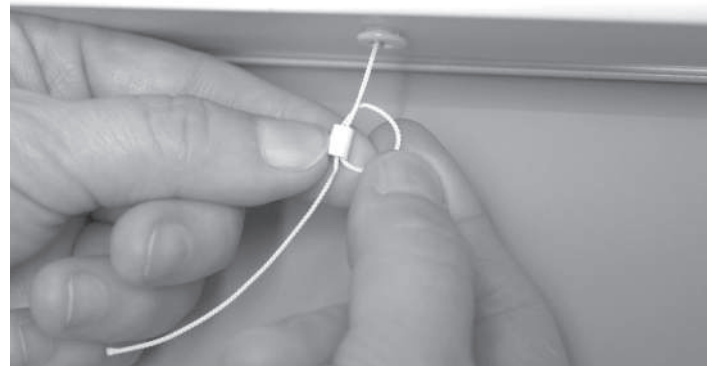
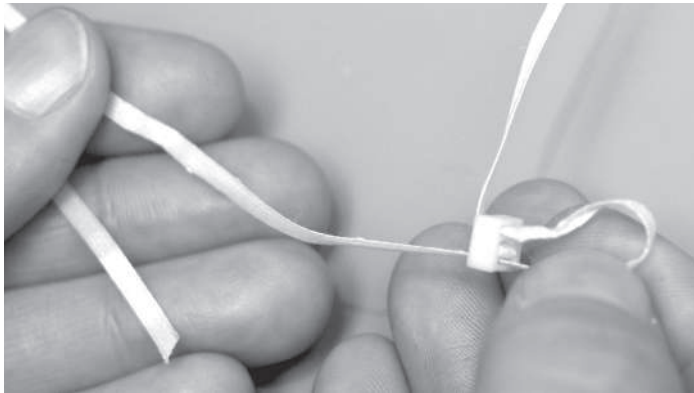

3. Remove the lift tapes or cord spools from the headrail.

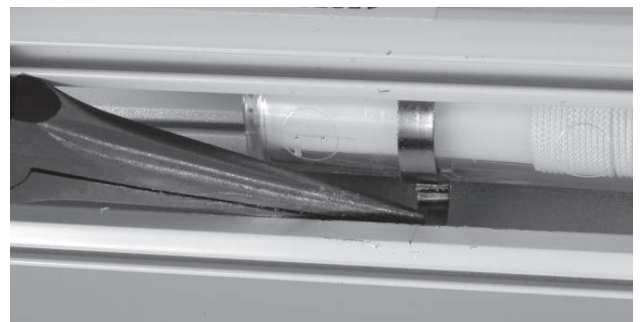
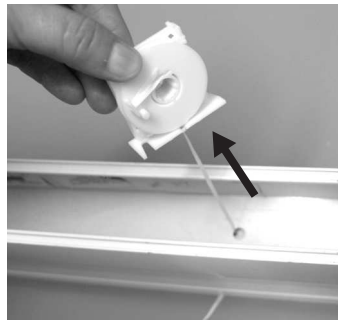

$\frac{3}{8}$ " Shades: Use needlenose pliers to grab the end of a spring and push downward to free the end from the rail. Twist the clip and slide away from the spool to remove.

Grasp the spool from the end toward the clutch, making sure to grasp the bottom of the spool and not just the cover. Lift up on the end to release the legs from the rail. Lift up on the other end of the spool, then slide the spool out of the rail.



4. Thread the tape or cord from the new spool assemblies through the fabric stack and bottom rail using the provided threading tool.

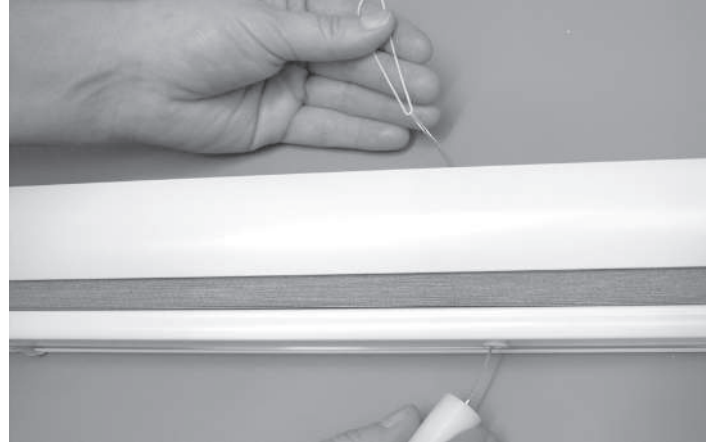
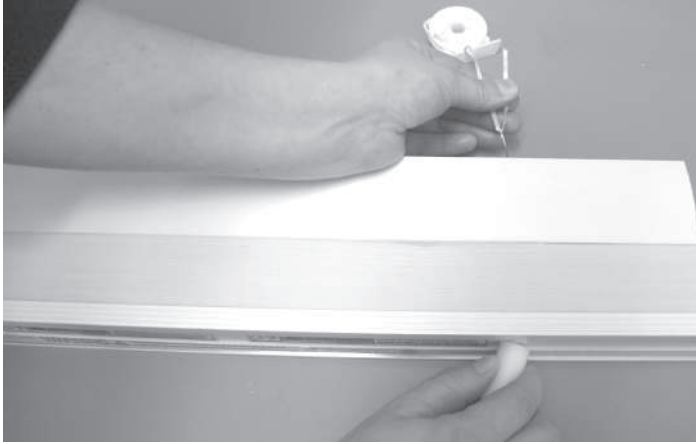

- Insert the threading tool through the pocket in the bottom rail, the fabric, and the headrail.
- Thread the tape or cord through the eye of the threading tool and pull back down through the fabric and rails.

Note: Be careful not to twist or crease the lift tape.

5. Install the new spool assemblies into the headrail.

$\frac{3}{4}$ " Spool Assembly



- Insert the assemblies with the spool facing the clutch. The tape guides on the spools fit into the holes in the headrail. Insert at an angle, then rotate the spool into place.

$\frac{3}{8}$ " Spool Assembly

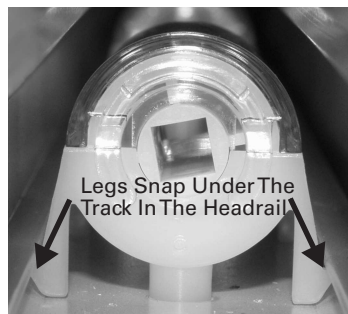

- Slide the spools onto the headrail with the cord end toward the control side of the headrail.
- Slide the back legs of the spool under the track in the headrail.
- Position the pin of the spool over the rout hole in the headrail and pull the cord taut from under the bottom rail. Snap the spool downward into place.



6. Pull out all the cord or tape from the assemblies down through the fabric stack.
7. Measure and mark the cord to the ordered shade height plus 4 inches for adjustment.
8. Thread the new buckles or ferrules onto the end of the tapes or cords to the mark.

$\frac{3}{4}$ " Spool Assembly

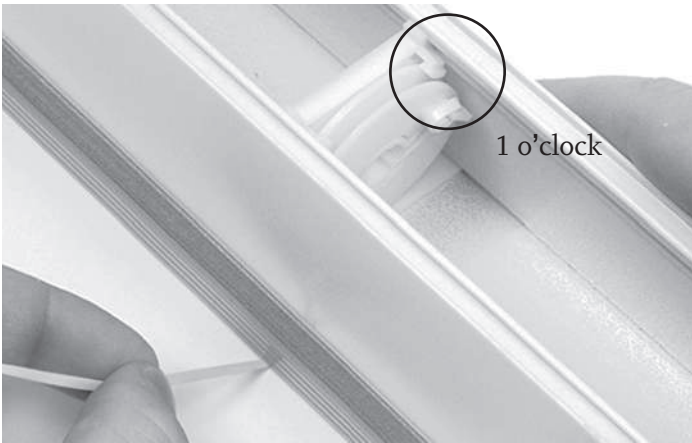

$\frac{3}{8}$ " Spool Assembly



After pulling out all the tape, be sure the tabs on all the tape spools are in the 1 o'clock position.

9. Insert the buckles or ferrules into the pockets in the bottom rail.

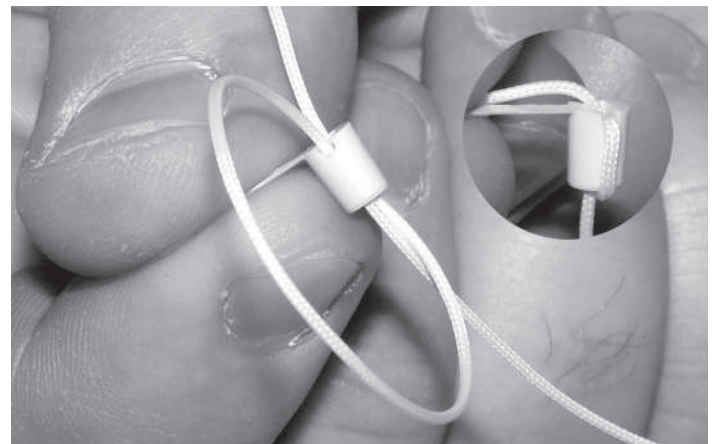
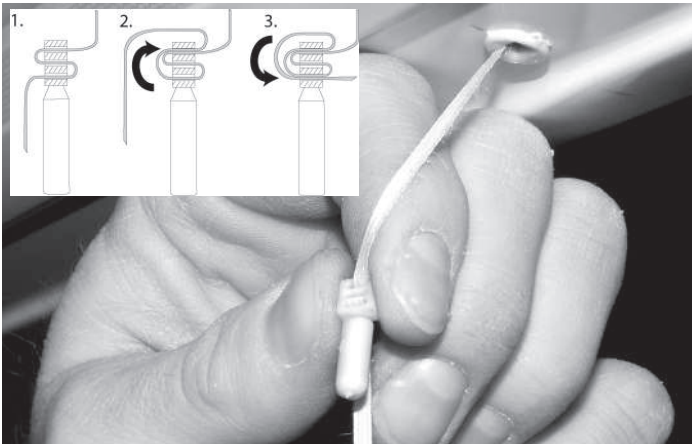

**Note:** Make sure the tape is not creased or twisted when threading the buckles.

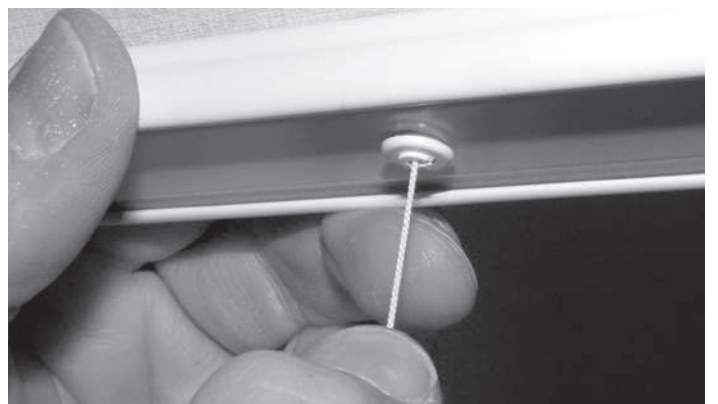
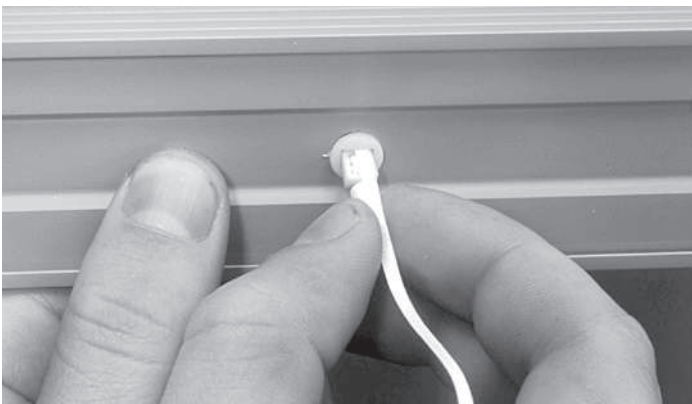

**Note:** Do not break off the handles yet.

## Reassemble and Adjust the Shade

1. Insert the metal shaft and attached clutch through the spool assemblies in the headrail.  
**HINT: BE SURE THE SPOOLS DO NOT TURN AS YOU PASS THE SHAFT THROUGH.**

$\frac{3}{4}$ " Shade

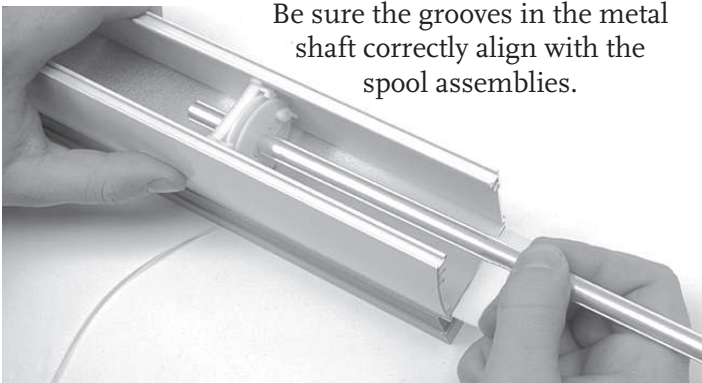

Be sure the grooves in the metal shaft correctly align with the spool assemblies.

$\frac{3}{8}$ " Shade

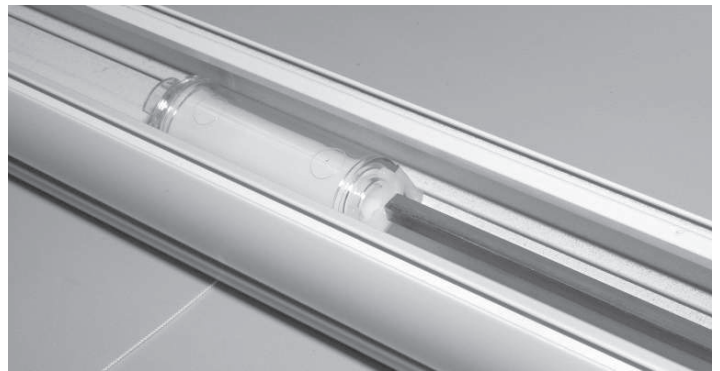

2. Reinsert the retainer clip.

$\frac{3}{4}$ " Shade



$\frac{3}{4}$ " Shade: Insert the retainer clip on the clutch side of the spool assembly farthest from the clutch.

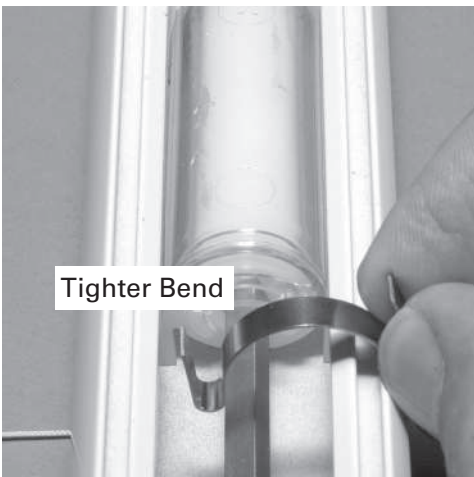

Tighter Bend



- $\frac{3}{8}$ " Shade: Hold the clip so that the tighter bend is free and positioned toward the curved side of the headrail. Place the end of the clip under the edge of the headrail, then slide the clip to the center of the spool. Use a flat-blade screwdriver to press the other end of the spring into place.

### 3. Reinstall the shaft.

Align the tabs on the clutch with the grooves in the headrail and slide the clutch into place.

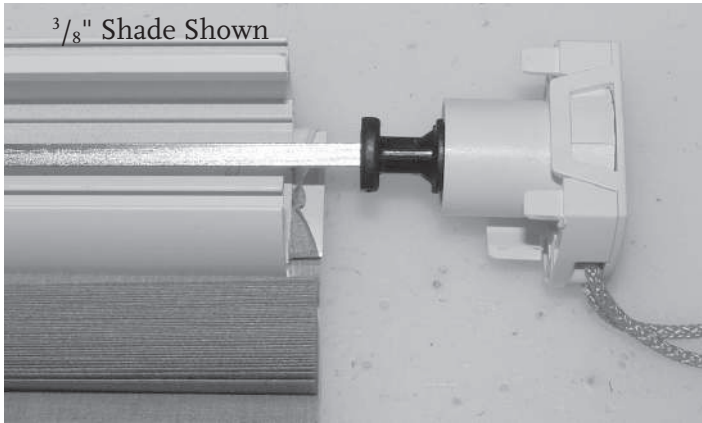

### 4. Install the shade back into the mounting brackets.

- Lower the shade about 4".
- With the colored side of the shade facing you, insert the headrail at an angle so the top groove of the headrail fits into the notch at the top of the bracket.
- Be careful not to pinch the fabric in the groove of the headrail.
- Rotate upward to snap into place.

### 5. Lower the bottom rail to the window sill.



Pull any excess lift tape out of the bottom rail until the tape is taut.

$\frac{3}{4}$ " Shade

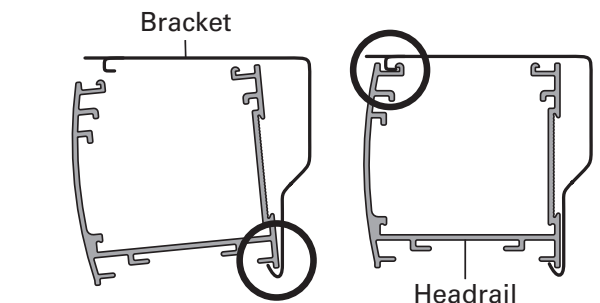

$\frac{3}{8}$ " Shade

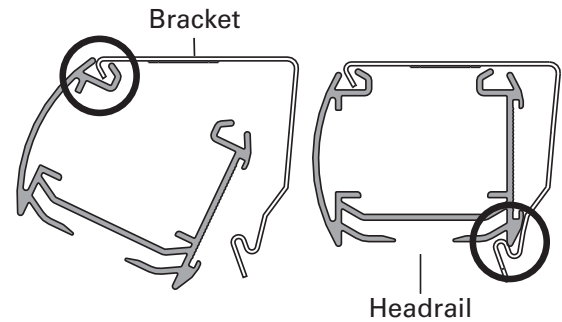

6. Adjust shade height by adjusting the buckles or the ferrules in the bottom rail.

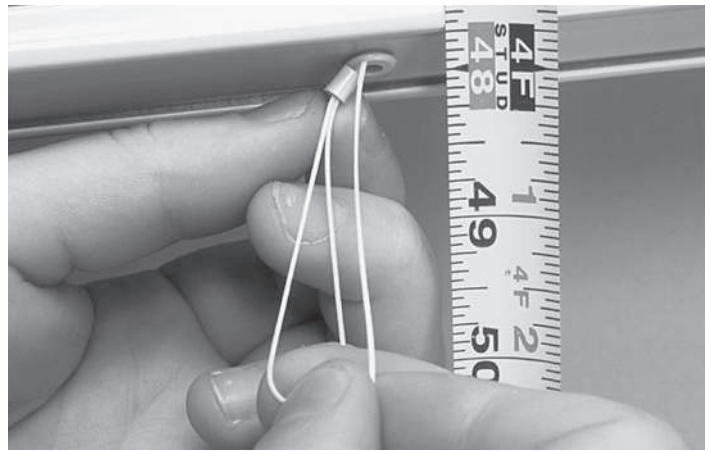
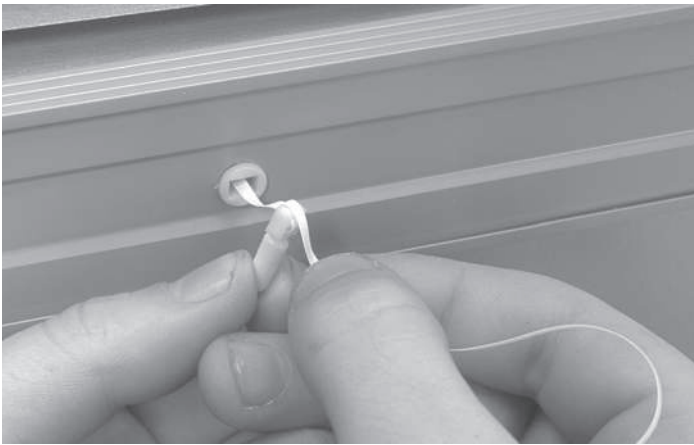

7. Check that the cord loop and fabric move freely and do not catch on the rails.  
Check that the shade drop is at the correct location.

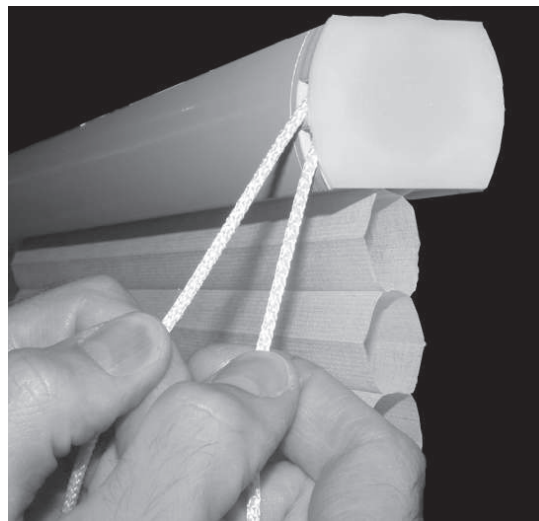

**Note:** Check that the fabric is not puckered, wrinkled, or pinched.

8. Break off the handles. Either trim the excess tape or cord from the bottom of the rail or affix it to the bottom rail.

Be sure to leave enough extra tape or cord in the bottom rail to allow access to the buckles or ferrules for future adjustments.

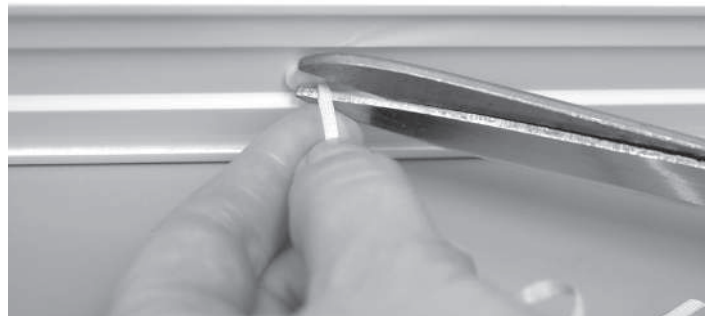
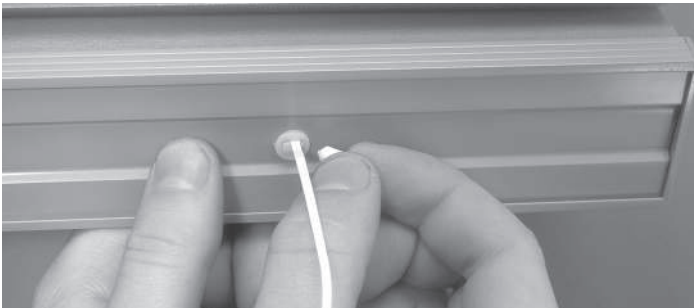

## Attach the Universal Cord Tensioner

**Important:** Before you proceed, you must first slide the cord tensioner to the bottom of the cord loop.

1. Insert a small screwdriver, punch, or awl through the screw hole at the bottom of the cord tensioner.
2. Move the screw hole down to the indicator line to release the safety mechanism.
3. Slide the cord tensioner down to the bottom of the cord loop.
4. Attach the cord tensioner according to the instructions provided with the Universal Cord Tensioner Installation Kit.

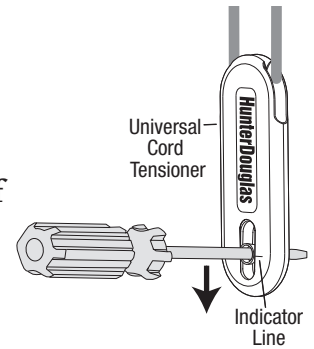

**WARNING:** It is imperative that the cord tensioner be properly secured to the wall or window frame to reduce children's access to the cord loop. Young children can strangle in cord loops. They can also wrap cords around their necks and strangle.

**CAUTION:** The shade will not operate properly unless the cord tensioner is secured. A Universal Cord Tensioner Installation Kit has been included with your shade. Follow the instructions in the kit to correctly secure the cord tensioner.



**WARNING**

For more safety information call 1-888-501-8364 in the U.S. or 1-866-662-0666 in Canada.

Young children can **STRANGLE** in cord loops. They can also wrap cords around their necks and **STRANGLE**.

- Always keep cords out of the reach of children.
- Move cribs, playpens and other furniture away from cords. Children can climb furniture to get to cords.

### Cord Loop Shades

- Attach the cord tensioner on the cord loop to the wall or window casement. This can help prevent children from pulling cord loops around their necks.
- Hunter Douglas provides a cord tensioner installation kit with instructions for attaching the cord tensioner. For the shade to operate properly, the cord tensioner must be correctly mounted and secured.
- Only Hunter Douglas supplied cord tensioners and hardware should be used. Replacement parts may be obtained by contacting the Hunter Douglas Customer Information Center at 1-888-501-8364.







For assistance, call the  
Hunter Douglas  
Customer Information Center at  
1-888-501-8364  
Visit our Web site at [hunterdouglas.com](http://hunterdouglas.com)



**HunterDouglas**

[hunterdouglas.com](http://hunterdouglas.com)

© 2011 Hunter Douglas ® Registered trademark of Hunter Douglas  
™ Trademark of Hunter Douglas



PCN 5109601056

Rev. 4/11