

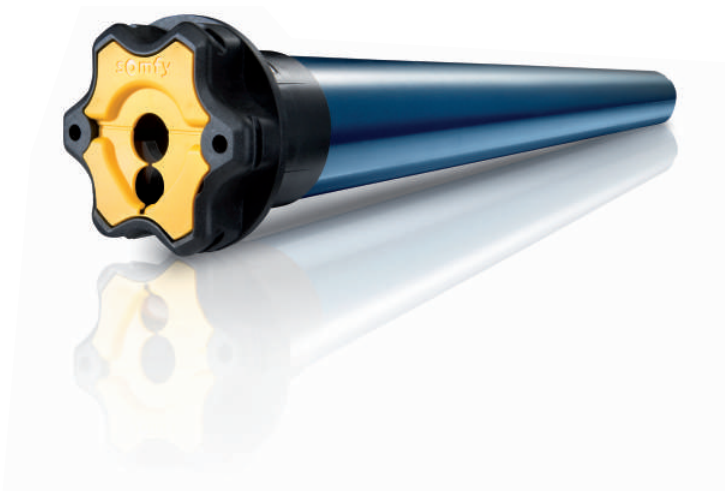

# Sonesse® Quiet Motors Just Got Stronger

6Nm Sonesse® 50 Motor Line



**NEW**

HOME MOTION by  
**somfy**®

# Somfy now offers a full range of Sonesse® 50 4Nm & 6Nm quiet motors for all applications

## Quiet, Strong and Innovative... **NEW** 6Nm Sonesse® 50 Motor

With the Sonesse® range, Somfy makes acoustic performance the added value of your solutions, without sacrificing strength. Our new 6Nm motor now brings all of the benefits of our Sonesse® range to large multi-banded/coupled window covering applications.

### WHY CHOOSE SOMFY'S SONESSE® RANGE?

#### Quiet and Strong:

- Stronger torque for larger applications including multi-banded/coupled window coverings
- \*Uniform quiet operation in both the up and down directions under 40dBA.

#### Wide Range of Solutions:

- Interior and exterior applications
- Residential and commercial markets
- RTS, wired and RS485 integrated network options

#### Simplified Fabrication and Installation:

- Utilizes existing fabrication methods on the market today
- Compatible with leading industry hardware solutions
- Can be installed in 6 different orientations
- Advanced design enables simple "Snap-On" connection for roller tube adapters.

#### Superior Quality:

- Our motors undergo rigorous endurance, acoustic, radio, mechanical, electrical and safety tests in our 65,000 sq. ft. quality control and testing facility.
- More than 600 approved standards worldwide
- Manufactured and sold over 100 million motors

\* Sound level measured at 3 feet from end product at maximum rated torque.

#### Streamlined Programming:

- RTS limits are set via radio transmitter.
- Wired simple push-button limit setting
- Improved RS485 commissioning process:
  - Motor auto discovery
  - Motor position feedback
  - Multiple intermediate positions
  - Collision detection
  - Compatibility with Somfy's animeo® IP system
  - Backward compatibility provides seamless integration with existing Somfy Digital Network projects.

#### Simple Electrical Connection:

- Available with UL approved 5-15P NEMA plug-in motor cable
- Plug-in option eliminates the need for an electrician.
- Motor cable length can be customized to meet your installation requirements.

#### All Sonesse® Motors are UL and CSA Recognized

- All SOMFY motors are UL Recognized and can be found under the following file numbers: E60495, E60888, E63714



# Sonesse® 50 4Nm and 6Nm

## Designed for Comfort... Designed for Success

Somfy's global team of engineers have developed the Sonesse® range of quiet motors and accessories using state-of-the-art research and development tools. In total, Somfy has 5 registered patents for the Sonesse® range:  
**US 8253288, US 8469171, US 7726379, US 7151464, US 7034899**

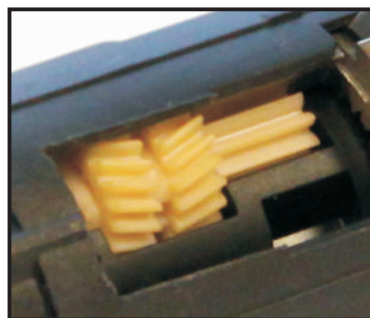

Compatible with all Somfy Snap-on drive wheels

Innovative and patented helical gearbox ensures uniform sound quality in both up and down directions.

Electronic Limit Switch Unit with Integrated RTS

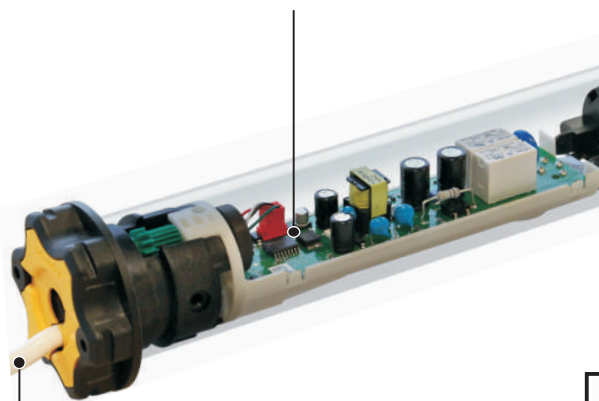

Includes Somfy patented antenna that is integrated into the power cord for enhanced reception.

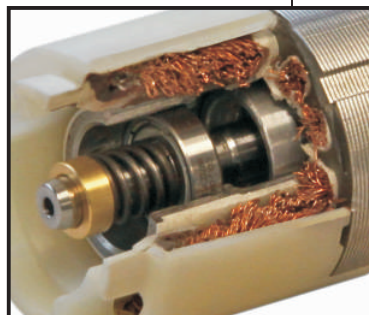

A newly patented, asynchronous, high quality, maintenance-free motor that provides perfect rotary part alignment supported by roller bearings.

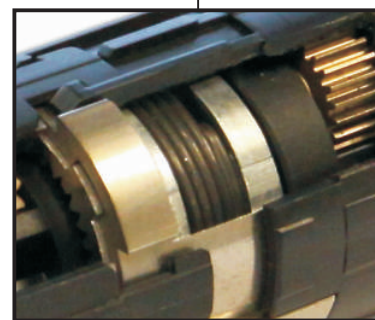

Newly patented and improved spring brake eliminates stopping and tilting noise.



As with all Somfy products, motors are backed by a 5 year warranty.

# Radio Technology Somfy® RTS – Sonesse® 50 RTS

Star Head and Round Head Motors



## STAR HEAD

504S2 1030065  
506S2 1001809

## ROUND HEAD

504S2RH 1030066  
506S2RH 1001806



Radio Technology Somfy® (RTS) allows for wireless radio control of motorized window coverings via the RTS family of controls.

## Technical Features

<b>Voltage Supply</b>	120V AC, 60Hz
<b>Index Protection Rating</b>	504 - IP 31 (interior use) 506 - IP 44 (interior & exterior use)
<b>Limit Switch Type</b>	Electronic RTS
<b>Limit Switch Capacity</b>	250 Turns
<b>Temperature Working Range</b>	504: 32°F to 140°F (0°C to 60°C) Interior use 506: -4°F to 158°F (-20°C to 70°C) Interior and exterior use
<b>Insulation Class</b>	Class 1 for 120V
<b>Antenna</b>	Integrated into power cord. Power cord must be at least 12 inches and must not come in contact with metal
<b>Wiring</b>	Parallel wiring allowed in accordance with NEC and local electrical codes

## Dimensions

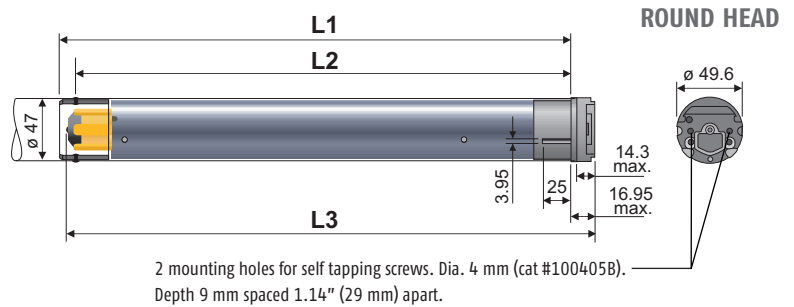
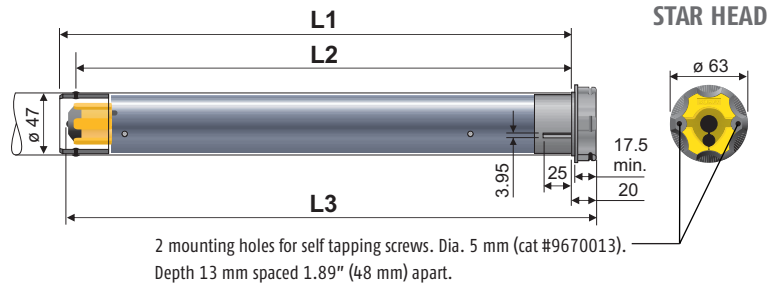

## Performances

	504	506
<b>Torque</b>	4 Nm	6 Nm
<b>Nominal Voltage</b>	120V / 60Hz	120V / 60Hz
<b>Rated Current</b>	.95A	1.2A
<b>Speed</b>	32 rpm	32 rpm
<b>Thermal Protection</b>	4 minutes	5 minutes
<b>Radio Frequency</b>	433.42 MHz	433.42 MHz
<b>*Sound Level</b>	≤ 44 dBA	≤ 40 dBA

Dimensions	504	506
<b>L1</b>	30.83 in (783 mm)	25.7 in (653 mm)
<b>L2</b>	30.31 in (770 mm)	25.2 in (640 mm)
<b>L3</b>	SH 31.34 in (796 mm) RH 31.22 in (793 mm)	SH 26.2 in (666 mm) RH 26.1 in (663 mm)
<b>Cable Length</b>	6.5ft (2 m)	6.5ft (2 m)

Optional cables with NEMA plugs available in 3 ft, 6 ft, 12 ft, 18 ft, 24 ft.

### \*Sound Level:

Sound level measured at 3 feet from end product at maximum rated torque.

### Fabrication Recommendations:

- Operational noise level is reduced when motor, tube, and mechanical accessories are properly adapted to motorized applications.
- Free play must be minimized between the accessories and the end product tube to ensure quiet performance of the motor.
- Interior Tube Diameter (ID) > 47mm must be respected.
- A motor crown adapter between motor and end product tube is required to ensure concentric operation of motor.
- 500 Series Drive Stop and Screw (9910004) is recommended to prevent noise and drive wheel separation from motor shaft.
- Somfy Soft Clip Drive Wheel Adapters (brown in color) are not recommended.

## Type of Cable

RTS  
120V / 60Hz  
3 conductor cable

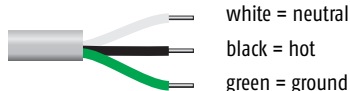

# Wired Technology – Sonesse® 50 RA

## Star Head and Round Head Motors (rapid limit adjustment)



### STAR HEAD

**504S2** 1030061  
**506S2** 1001814

### ROUND HEAD

**504S2RH** 1030062  
**506S2RH** 1001812



Offers control via power switching

## Technical Features

<b>Voltage Supply</b>	120V AC, 60Hz
<b>Index Protection Rating</b>	504 - IP 31 (interior use) 506 - IP 44 (interior & exterior use)
<b>Limit Switch Type</b>	Rapid Adjustment RA
<b>Limit Switch Capacity</b>	46 Turns
<b>Temperature Working Range</b>	504: 32°F to 140°F (0°C to 60°C) Interior use 506: -4°F to 158°F (-20°C to 70°C) Interior and exterior use
<b>Insulation Class</b>	Class 1 for 120V
<b>Wiring</b>	Do not parallel wire

## Dimensions

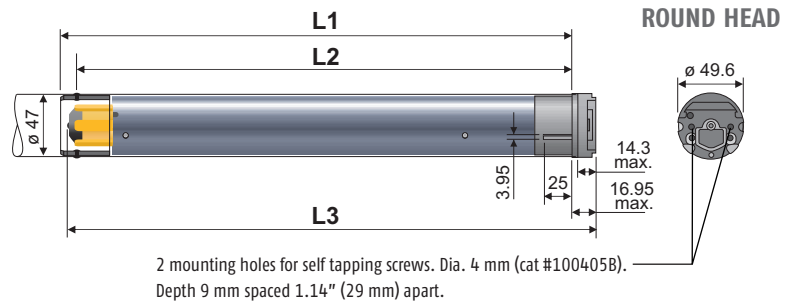
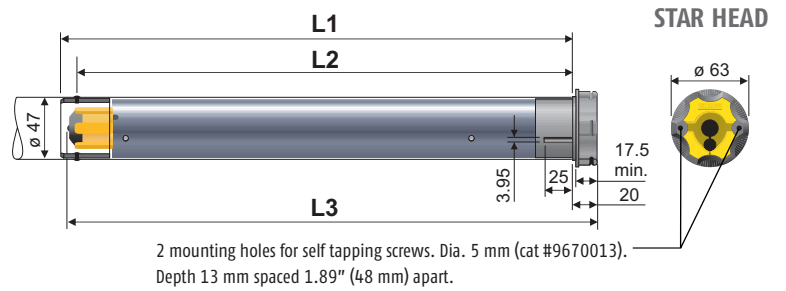

## Performances

	504	506
<b>Torque</b>	4 Nm	6 Nm
<b>Nominal Voltage</b>	120V / 60Hz	120V / 60Hz
<b>Rated Current</b>	.95A	1.2A
<b>Speed</b>	32 rpm	32 rpm
<b>Thermal Protection</b>	4 minutes	5 minutes
<b>*Sound Level</b>	≤ 44 dBA	≤ 40 dBA

Dimensions	504	506
<b>L1</b>	20.03 in (712 mm)	23.7 in (603 mm)
<b>L2</b>	27.60 in (701 mm)	23.2 in (590 mm)
<b>L3</b>	SH 28.58 in (726 mm) RH 28.46 in (723 mm)	SH 24.3 in (616 mm) RH 24.1 in (613 mm)
<b>Cable Length</b>	6.5ft (2 m)	6.5ft (2 m)

Optional cables with NEMA plugs available in 3 ft, 6 ft, 12 ft, 18 ft, 24 ft.

### \*Sound Level:

Sound level measured at 3 feet from end product at maximum rated torque.

### Fabrication Recommendations:

- Operational noise level is reduced when motor, tube, and mechanical accessories are properly adapted to motorized applications.
- Free play must be minimized between the accessories and the end product tube to ensure quiet performance of the motor.
- Interior Tube Diameter (ID) > 47mm must be respected.
- A motor crown adapter between motor and end product tube is required to ensure concentric operation of motor.
- 500 Series Drive Stop and Screw (9910004) is recommended to prevent noise and drive wheel separation from motor shaft.
- Somfy Soft Clip Drive Wheel Adapters (brown in color) are not recommended.

## Type of Cable

**Wired**  
**120V / 60Hz**  
**4 conductor cable**

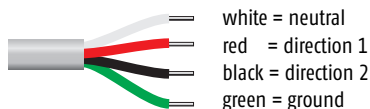

506S2 1002286



A new generation of intelligent motors that are controlled and monitored via Somfy digital network solutions and animeo IP total solar management system.

### Technical Features

<b>Voltage Supply</b>	120V AC, 60Hz
<b>Index Protection Rating</b>	506 – IP 44 (interior & exterior use)
<b>Limit Switch Type</b>	Electronic
<b>Limit Switch Capacity</b>	300 Turns
<b>Temperature Working Range</b>	-4°F to 158°F (-20°C to 70°C) Interior and exterior use
<b>Insulation Class</b>	Class 1 for 120V
<b>Wiring</b>	Parallel wiring allowed in accordance with NEC and local electrical codes

### Performances

<b>Torque</b>	6 Nm
<b>Nominal Voltage</b>	120V / 60Hz
<b>Rated Current</b>	1.2A
<b>Speed</b>	32 rpm
<b>Thermal Protection</b>	5 minutes
<b>*Sound Level</b>	≤ 40 dBA

### Dimensions

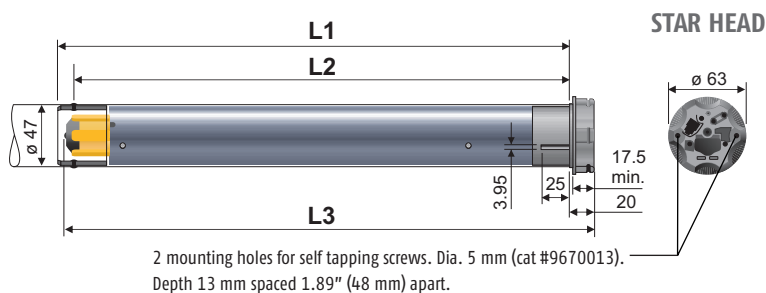

<b>L1</b>	25.7 in (653 mm)
<b>L2</b>	25.2 in (640 mm)
<b>L3</b>	26.2 in (666 mm)
<b>SJTW Power Cable Length</b>	9.8 ft (3 m)
<b>Data Cable (must be ordered separately)</b>	Customizable and available in various lengths

Optional cables with NEMA plugs available in 3 ft, 6 ft, 12 ft, 18 ft, 24 ft.

### Type of Cable

**RS485: 120V / 60Hz**  
3 conductor cable



#### \*Sound Level:

Sound level measured at 3 feet from end product at maximum rated torque.

#### Fabrication Recommendations:

- Operational noise level is reduced when motor, tube, and mechanical accessories are properly adapted to motorized applications.
- Free play must be minimized between the accessories and the end product tube to ensure quiet performance of the motor.
- Interior Tube Diameter (ID) > 47mm must be respected.
- A motor crown adapter between motor and end product tube is required to ensure concentric operation of motor.
- 500 Series Drive Stop and Screw (9910004) is recommended to prevent noise and drive wheel separation from motor shaft.
- Somfy Soft Clip Drive Wheel Adapters (brown in color) are not recommended.

### Data Cable: RJ9/RJ45 (sold separately)

#### RJ9 connects to motor

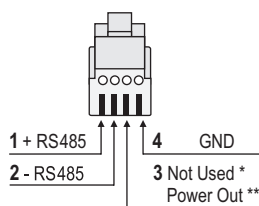

\* Data cable (black) for animeo IP networks  
\*\* Data cable (grey) for powering external modules

#### RJ45 connects to network

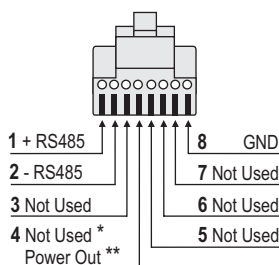

#### 4 Cond. 26AWG modular cable with RJ9 on one end and RJ45 other end – (RTS, Z-Wave, ZigBee modules)

**GREY WITH POWER OUT**

2.5 ft long	#9018545
8 ft long	#9018546
12 ft long	#9018547
24 ft long	#9018548

#### 4 Cond. 26AWG modular cable with RJ9 on one end and RJ45 other end – (SDN - animeo IP)

**BLACK WITHOUT POWER OUT**

2.5 ft long	#9018541
8 ft long	#9018542
12 ft long	#9018543
24 ft long	#9018544

# Flexible and Robust Control Options

The Sonesse® 50 range of 4Nm and 6Nm motors provide unsurpassed options in motorized window covering control. Our wide variety of solutions ensures you can always provide a Somfy-powered solution regardless of specification needs.

## RADIO TECHNOLOGY SOMFY® (RTS)



### TELIS HAND-HELD REMOTE COLLECTION



Telis 1 RTS Pure  
Single Channel Remote  
1810632



Telis 4 RTS Pure  
Five Channel Remote  
1810633



Telis 1 RTS Silver  
Single Channel Remote  
1810639



Telis 4 RTS Silver  
Five Channel Remote  
1810641



Telis 1 RTS Lounge  
Single Channel Remote  
1810650



Telis 4 RTS Lounge  
Five Channel Remote  
1810652



Telis 1 RTS Patio  
Single Channel  
Remote  
1810643



Telis 4 RTS Patio  
Five Channel  
Remote  
1810645



Telis 16 Channel RTS  
Pure Remote with  
On-screen display  
1811081



Telis 16 Channel RTS  
Silver Remote with  
On-screen display  
1811082



Telis 1 Chronis RTS  
Pure Timer  
1805237



Telis 1 Chronis RTS  
Silver Timer  
1805238

visit [www.somfypro.com](http://www.somfypro.com) to learn more about RTS controls, accessories and interfaces.

### DECOFLEX WIREFREE™ RTS WALL SWITCHES



DecoFlex 1 Channel  
1810897



DecoFlex 2 Channel  
1811068



DecoFlex 3 Channel  
1811071



DecoFlex 4 Channel  
1811074



DecoFlex 5 Channel  
1810813

- Wall Switches shown in white. Also available in black, ivory, and almond finishes.
- Shown assembled with printed channel buttons.
- Custom engraved buttons are also available.

### DECOFLEX WIREFREE™ RTS TABLE TOP



Black  
1811051\*



Silver  
1810972\*



White  
1811185\*

\*DecoFlex Switch sold separately from Table Top Accessory.

visit [www.somfypro.com/decoflex](http://www.somfypro.com/decoflex)

## animeo® IP



animeo IP is a total solar management system utilizing Somfy-powered intelligent motorized window coverings as well as digital keypads and weather sensors. The system's controllers, sensors and keypads can be added to both new and existing Somfy Digital Network installations for comprehensive solar management as either a stand-alone solution or integrated into third party control systems. An intuitive user interface allows for simplified commissioning, building management and technical support, featuring drag-and-drop programming, motor auto discovery and at-a-glance system status update.



animeo® IP Building Controller #1822314

visit [www.somfypro.com/animeo](http://www.somfypro.com/animeo)

[www.somfypro.com](http://www.somfypro.com)

**SOMFY SYSTEMS, INC.**  
**NORTH AMERICA HEADQUARTERS**  
121 Herrod Blvd.  
Dayton, NJ 08810  
Phone: (800) 227-6639  
Phone: (609) 395-1300  
Fax: (609) 395-1776

**SOMFY FLORIDA**  
6100 Broken Sound Pkwy  
Northwest, Suite 14  
Boca Raton, FL 33487  
Phone: (877) 227-6639  
Phone: (561) 995-0335  
Fax: (561) 995-7502

**SOMFY CALIFORNIA**  
15291 Barranca Pkwy  
Irvine, CA 92618  
Phone: (877) 727-6639  
Fax: (949) 727-3775

**SOMFY ULC**  
**SOMFY CANADA DIVISION**  
5178 Everest Drive  
Mississauga, Ontario L4W2R4  
Phone: CN: (800) 667-6639  
CN: (905) 564-6446  
Fax: (905) 238-1491

### **Somfy: the creator of intelligent and sustainable movement**

With over 100 million motors sold and 40 years experience providing motorization solutions for building openings, Somfy has developed an unrivaled choice of solutions including motors, control units, automatic devices and transmission technologies. Somfy is the world leader in Home Motion: Intelligent and sustainable movement in residential and commercial buildings.



HOME MOTION by  
**somfy**®